

SERVICE MANUAL

SUPER INTEGRATED AMPLIFIER

SANSUI AU-X1

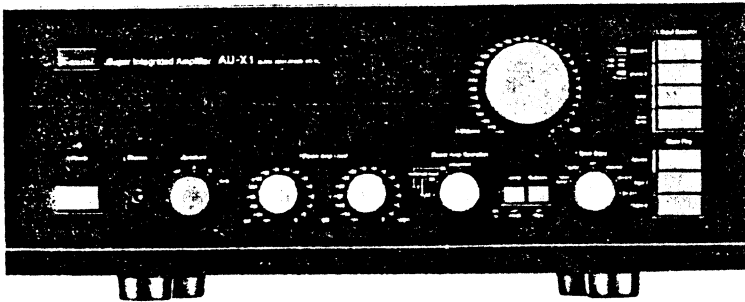

SPECIFICATIONS

Power output

Min. RMS, both channels driven, from 5 to 20,000 Hz,
with no more than 0.007 % total harmonic distortion
160 watts per channel into 8 ohms

Load impedance 8 ohms

Total harmonic distortion (POWER AMP IN)

. less than 0.007 % at or below
rated min. RMS power output

**Intermodulation distortion (70 Hz : 7 kHz = 4:1 SMPTE
method) (POWER AMP IN)**

. less than 0.007 % at or below
rated min. RMS power output

Rise time 0.5 μ sec

Slew rate ± 260 V/ μ sec

Frequency response (at 1 watt) (POWER AMP IN)

. DC to 500,000 Hz +0 dB -3 dB

Damping factor (1 kHz, both channels driven)

. 100 into 8 ohms

RIAA curve deviation (PHONO, 20 Hz to 20 kHz)

. +0.2 dB, -0.2 dB

**Input sensitivity and impedance (1 kHz, for rated power
output)**

PHONO (MC) 0.1 mV/200 ohms

(Max. input capability; 40 mV at 1 kHz, less than
0.01 % total harmonic distortion)

PHONO (MM) 2.5 mV/47 kilohms

(Max. input capability; 330 mV at 1 kHz, less than
0.01 % total harmonic distortion)

AUX/TUNER, TUNER, TAPE PLAY

. 200 mV/47 kilohms

POWER AMP IN 1 V/47 kilohms

Output level and impedance (1,000 Hz)

TAPE REC 200 mV into 47 kilohms/
600 ohms

PREAMP OUT 1 V into 47 kilohms/
600 ohms

Channel separation (1 kHz, at rated power output)

PHONO (MC) 70 dB

PHONO (MM) 75 dB

AUX/TUNER, TUNER, TAPE PLAY

. 80 dB

Hum and noise (short-circuit, A-network)

PHONO (MC) 76 dB

PHONO (MM) 91 dB

AUX/TUNER, TUNER, TAPE PLAY

. 100 dB

Controls

SUBSONIC -3 dB (16 Hz), 6 dB/oct

JUMP -14 dB

Power requirements

Power voltage 100, 120, 220, 240 V (50/60 Hz)

Power consumption

Rated consumption

. 500 watts

Dimensions 480 mm (18-15/16") W

197 mm (7-13/16") H

450 mm (17-3/4") D

Weight 27.7 kg (61.1 lbs) net

30.4 kg (67.0 lbs) packed

* Design and specifications subject to changes without
notice for improvements.



1. BLOCK DIAGRAM

<SIGNAL BLOCK>

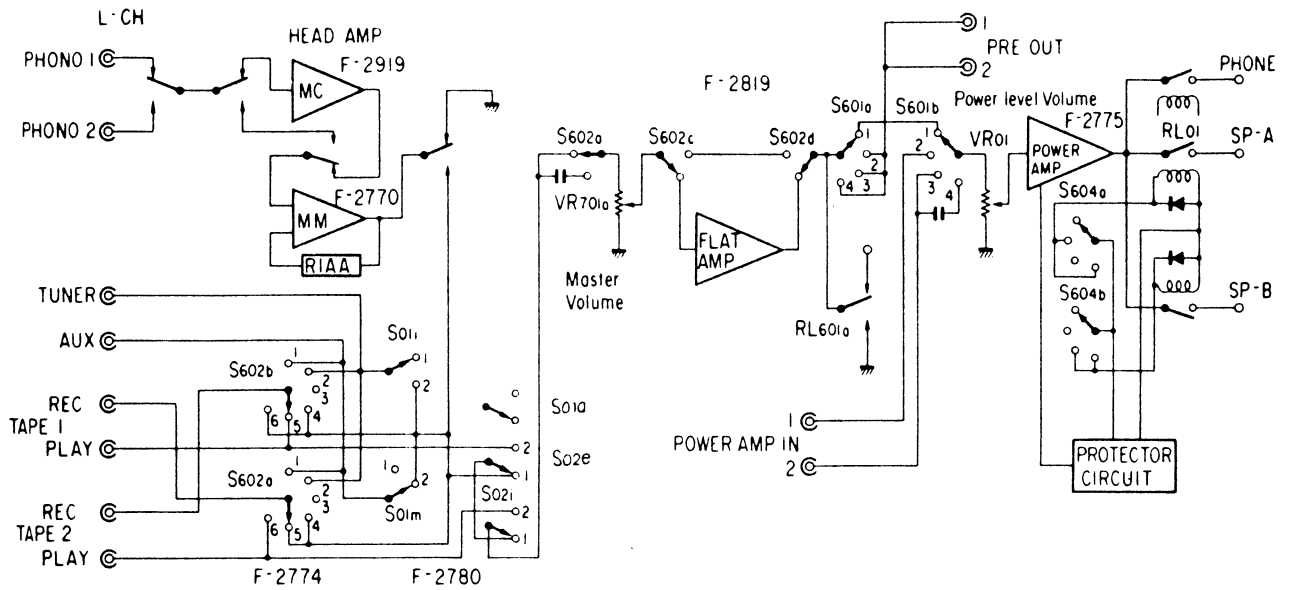

- | | | | |
|---|---|---|--|
| <p>F-2780, F-2776 Selector
 S01(b-d) Phono 1---2 (ON)
 S01(e-h) Phono 2---2
 S01(i-l) Tuner ---2
 S01(m-p) Aux/Tuner--2</p> | <p>F-2780, F-2776 Tape Play
 S02(a-d) Source ---2
 S02(e-h) Tape 1---2
 S02(i-l) Tape 2---2
 2---ON (Release Type Switch)
 S0i--Shorting Switch</p> | <p>F-2774 Tape Copy
 S602(a-d)
 1. Aux/Tuner 5. 5-1-2
 2. Tuner 6. 5-2-1
 3. Off
 4. Source</p> | <p>F-2777 MM/MC Selector
 S01(a-b)
 Phono 2 1--MM
 2--MC
 Phono 1 1--MM
 2--MC</p> |
|---|---|---|--|

<RELAY BLOCK>

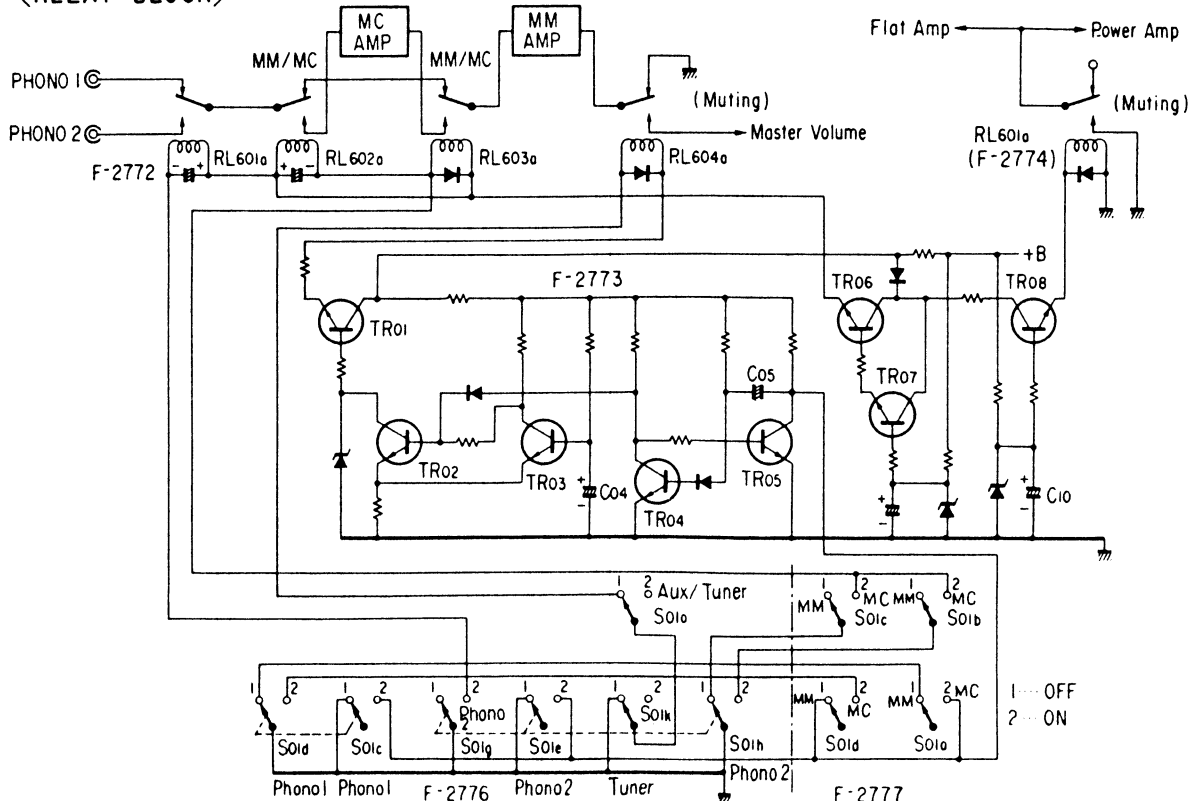

- The switch S01 is shorting type and generates pulse to function the relay circuit at switching.
- The S01 on F-2776, F-2777 is interlocking switch and only a contact or contacts joined by dotted line can be ON state (2 side) and others are released (1 side).

2. THE OPERATION & CHARACTERISTIC OF HIGH SPEED POWER TRANSISTOR

In order to up-grade the sound quality, AU-X1 employs the circuitry of the push-pull drive DC configuration from MC head amp to power amp stage, which provide superior dynamic and open-loop characteristics.

The improvement was made for parts such as volumes, wires, relays, electrolytic capacitors and semi-conductors. In particular, newly developed linear high speed device, LAPT (Linear Amplifier Power Transistor) is adapted in power stage, and the combination use of this high speed power transistor and diamond differential circuit allows slew rate of 260 V/ μ s and wide range low distortion amplification.

2-1. High Speed Power Transistor

The requirements for power transistor in order to elevate sound quality are;

- * to have high cut-off frequency, f_T (high speed device).
- * to make voltage dependance of DC forward-current transfer ratio, h_{FE} be little and have excellent linearity.
- * to have a large A.S.O. (Area of Safe Operation) and strong endurance against break-down.

The use of high speed power transistor with requirements above together with circuit improvement is effective for achievement of wide range and low distortion amplification. Transistors to meet with these requirements are both bi-polar and field effect transistor (FET).

Note: Cut-off frequency, f_T shows the frequency at which the small signal current gain will be 1 (0 dB) in common emitter circuit.

Comparison between bi-polar and field effect type as power transistor.

Table 1; Comparison of bi-polar and field effect type as a power device.

Characteristics	Bi-polar type	Field effect device junction type FET SIT	MOS FET
Input impedance	low	high	high
Thermal coefficient of operating current	positive	negative	negative
Stored carrier effect (Carrier storage effect)	exist	none	none
Transfer characteristic	exponential	square	square
Idring current as a output device	little	large	large
Output characteristic	pentode	triode	pentode
State at no input bias	off	on	on
Current path (Channel)	vertical	vertical	vertical & horizontal
Threshold voltage	low	inter-mediate	high
Cost	low	high	high

The advantages of FET are high input impedance and no thermal run-away because of negative thermal coefficient of operating current, however, there still remains price problem on FET, in addition, bi-polar type high speed power transistor are variously developed and becoming common so that AU-X1 employs bi-polar type power transistor (LAPT).

2-2. The Configuration of High Speed Transistor

In order to increase the cut-off frequency, f_T , it is necessary to make transistor base as thin as possible, but it oppose to A.S.O. (Area of Safe Operation) to enlarge. When making the transistor base thin, the injected current density is increased so that junction is destroyed by second-breakdown. To solve above problem, the construction of power transistor (LAPT) is parallel connection of divided 35 of small signal transistors, in addition, the defusion resistor is made at each emitter of divided transistor to equalize the flowing current.

Fig. 1 Illustration of emitter ballast resistor made by defusion.

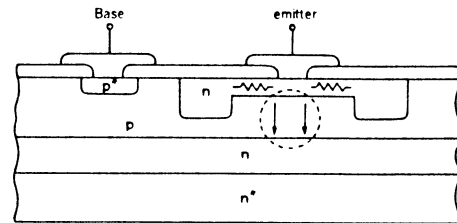

Fig. 2 Equivalent circuit of ballast resistor defused to emitter of transistor.

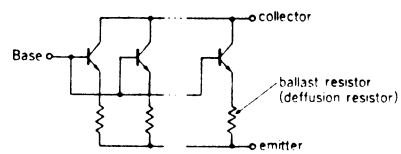
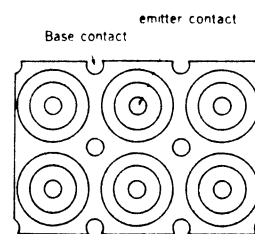

Fig. 3 Surface of LAPT before evaporation.



By connecting many small signal transistors with high f_T in parallel, power transistor with high f_T and large A.S.O. can be obtained. If there is current-concentration to one of small signal transistors, the voltage between emitter and base is decreased by the ballast resistor (defusion resistor) at emitter, which causes internal negative feedback and relieves the current-concentration.

2-3. The Characteristic and Merit of use of High Speed Power Transistor

- The relation between switching time, f_T , and h_{FE} of power transistor.

Fig. 4 Switching time

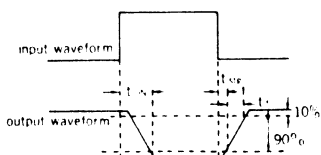
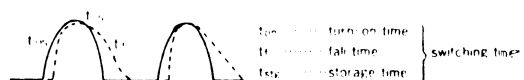
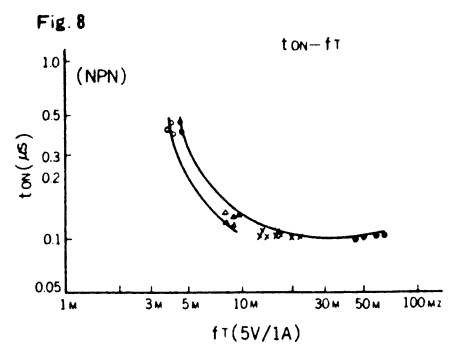
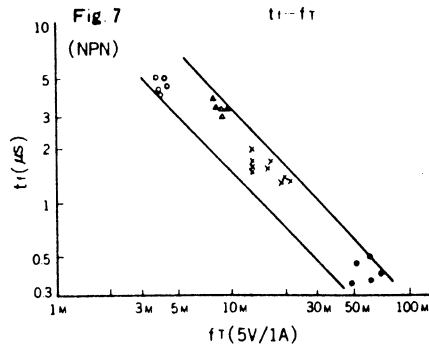
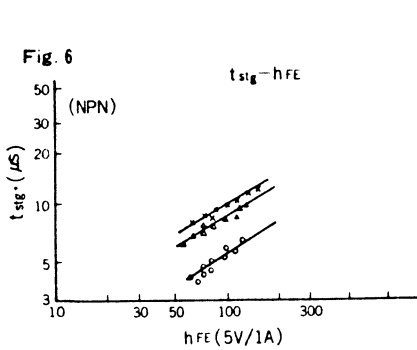

Fig. 5 Influence of switching time against sine-wave (of half cycle)



The more the switching time is shortened (high speed) the more the frequency range characteristic of power transistor is improved; this relation is indicated in Fig. 4), 5). Fig. 6), 7), 8) show the more the f_T is raised the more the switching speed is quickened.

- The relation between switching time, f_T and h_{FE} .
(x, Δ, o, ● showing the quantity of transistor & distribution)



Next, the following Figs show that the relation between high f_T of power transistor and short period of t_{stg} influences the improvement of distortion (THD) effectively in audio amplifier.

Fig. 9), 10) show the THD becomes better when t_{stg} is faster. Fig. 11), 12) illustrate the relation between output current wave-form of emitter and distortion wave-form. From these Figs, it is

obvious when the f_T of power transistor is low the output current wave-form becomes dull, and the switching function at B class push-pull operation is not performed precisely. These above phenomenon causes the increase of operating current and deterioration of distortion.

- Output wave-form & distortion wave-form near at clipping point.

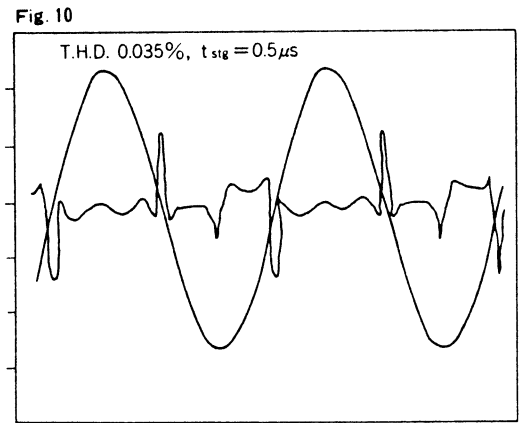
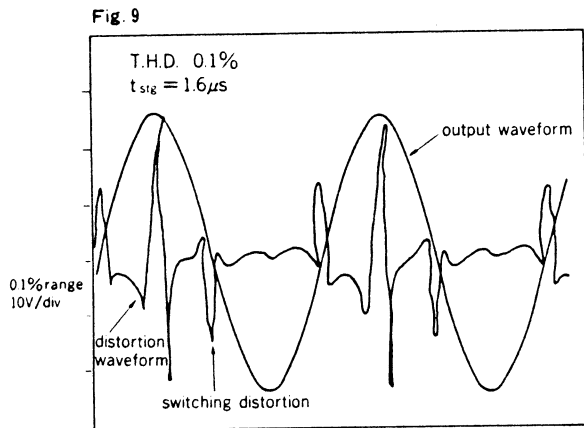

- Wave-forms of emitter current and distortion

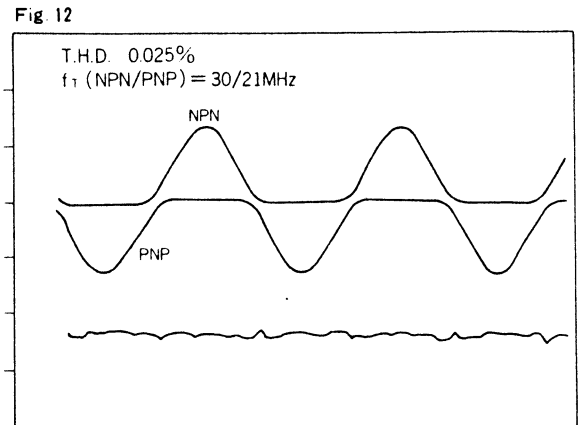
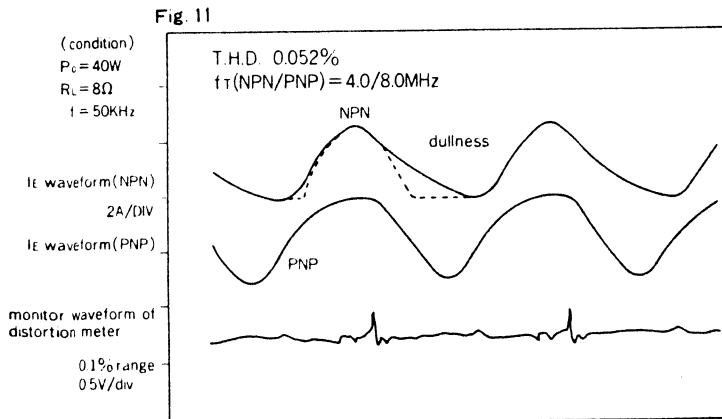

3. PARTS LOCATION & PARTS LIST

3-1. F-2917 MC Head Amp L-CH Circuit Board (Stock No. 7551421)

3-2. F-2918 MC Head Amp R-CH Circuit Board (Stock No. 7551431)

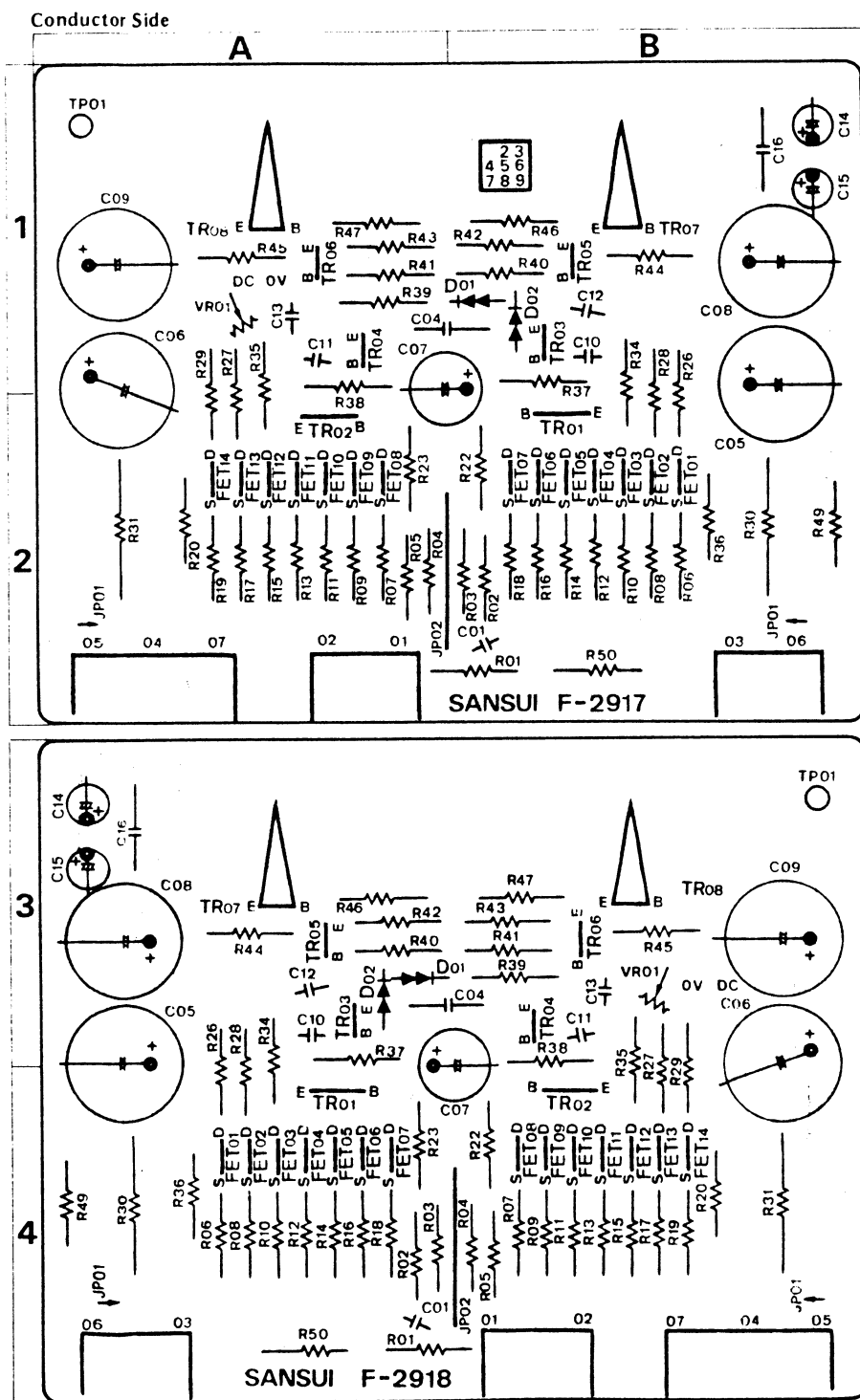

Parts List

Parts No.	Stock No.	Description	Position
•Transistor			
TR01	0301090 1	2SA992 F, E	F-2917 F-2918 2B 4A
TR02	0306740 1	2SC1845 F, E	2A 4B
TR03	0306740 1	2SC1845 F, E	1A 3A
TR04	0301090 1	2SA992 F, E	1A 3B
TR05	0306740 1	2SC1845 F, E	1A 3A
TR06	0301090 1	2SA992 F, E	1A 3A
TR07	0308501 2	2SD357 D, E	1A 3A
TR08	0303331 2	2SB527 D, E	1A 3B
•FET			
FET01 - 02	0370344 - 7	2SK163M1 M2, N1, N2 2B	4A
FET08 - 14	0370334 - 7	2SJ44M1 M2, N1, N2 2A	4B
•Varistor			
D 01	0340170	MV103	1B 3A
D 02	0340170	MV103	1B 3A
C			
C 01	0622102	1000pF 125V P.C.	2B 4A
C 04	0681014	0.047uF 400V P.C.	1A 3A
C 10	0622102	1000pF 125V P.C.	1B 3A
C 11	0622102	1000pF 125V P.C.	1A 3B
C 12	0623300	30nF 125V P.C.	1A 3A
C 13	0623300	30nF 125V P.C.	1A 3B
C 14 16	0602108	1uF 100V M.C.	1B 3A
C 17	0622102	1000pF 125V P.C.	
C 25 - 29	0681018	0.22uF M.C.	
R			
R 01	0280221	220Ω 1/3W C.R.	2B 4A
R 02	0280109	1Ω 1/3W C.R.	2B 4A
R 03	0280109	1Ω 1/3W C.R.	2B 4A
R 04	0280109	1Ω 1/3W C.R.	2A 4B
R 05	0280109	1Ω 1/3W C.R.	2A 4B
R 06 - 19	0280468	5.6Ω 1/3W C.R.	2A 4A, B
R 20	0280224	220Ω 1/3W C.R.	2A 4B
R 22	0280120	12Ω 1/3W C.R.	2B 4B
R 23	0280120	12Ω 1/3W C.R.	2A 4A
R 26	0280151	150Ω 1/3W C.R.	2A 4A
R 27	0280151	150Ω 1/3W C.R.	2A 4B
R 28	0280101	100Ω 1/3W C.R.	2B 4A
R 29	0280101	100Ω 1/3W C.R.	2A 4B
R 30, 31	0212150	15Ω 2W N.I.R.	2B, 2A 4A, 4B
R 34	0280561	560Ω 1/3W C.R.	1B 3A
R 35	0280511	510Ω 1/3W C.R.	1A 3B
R 36	0280224	220Ω 1/3W C.R.	2B 4A
R 37	0280221	220Ω 1/3W C.R.	1B 3A
R 38	0280221	220Ω 1/3W C.R.	1A 3B
R 39	0280479	4.7Ω 1/3W C.R.	1A 3B
R 40	0280152	1.5Ω 1/3W C.R.	1B 3A
R 41	0280152	1.5Ω 1/3W C.R.	1A 3B
R 42	0280391	390Ω 1/3W C.R.	1B 3A
R 43	0280391	390Ω 1/3W C.R.	1A 3B
R 44	0280479	4.7Ω 1/3W C.R.	1B 3A
R 45	0280479	4.7Ω 1/3W C.R.	1A 3B
R 46	0210478	0.47Ω 1/2W N.I.R.	1B 3A
R 47	0210478	0.47Ω 1/2W N.I.R.	1A 3B
R 48	0280101	100Ω 1/3W C.R.	
R 49	0280221	220Ω 1/3W C.R.	2B 4A
R 50	0280824	820Ω 1/3W C.R.	
VR01	1033570	100Ω B Center DC 0V Adj.	1A 3B

3-3. F-2770 Equalizer Amp L-CH Circuit Board (Stock No. 7551441)

3-4. F-2771 Equalizer Amp R-CH Circuit Board (Stock No. 7551451)

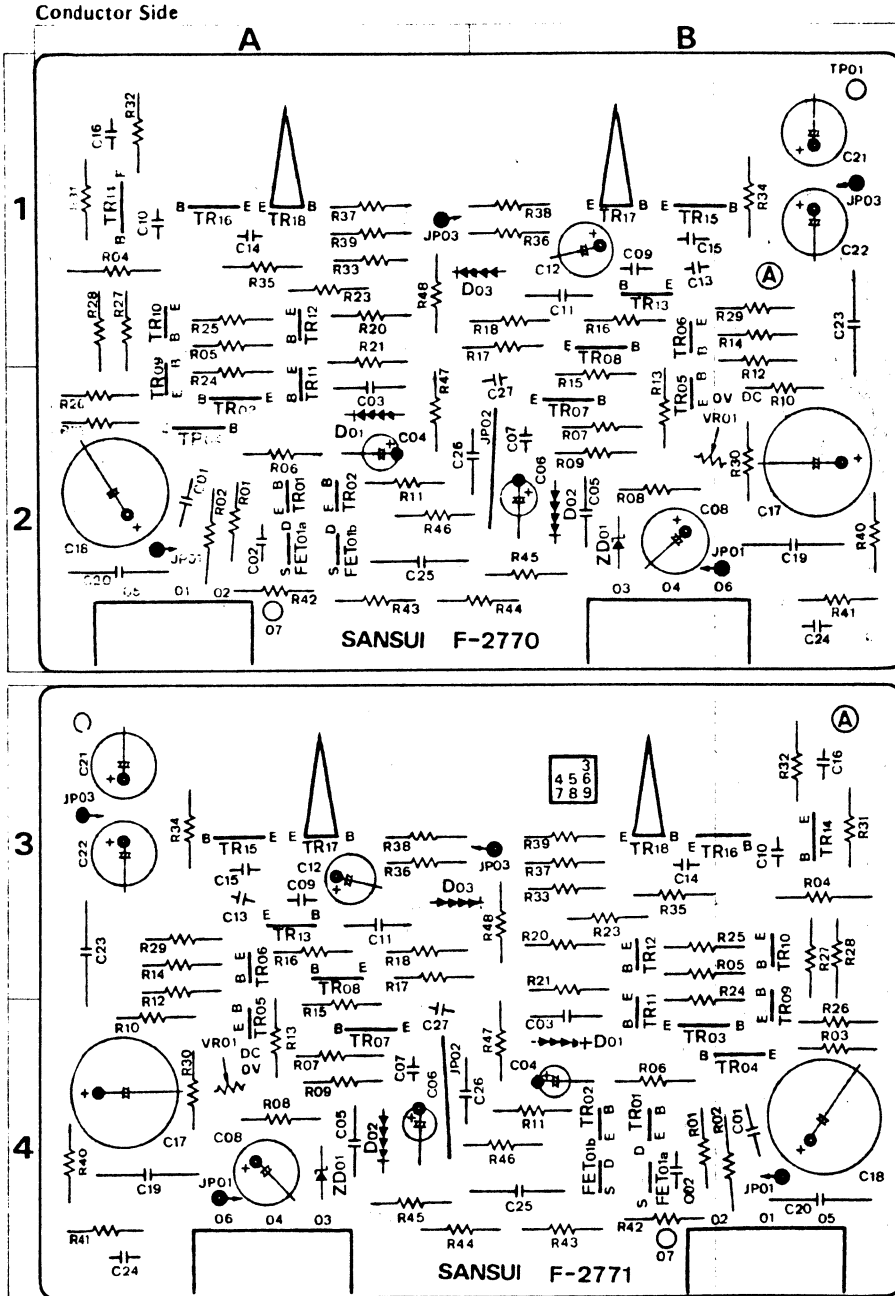

Parts List

Parts No.	Stock No.	Description	Position
•Transistor			
TR01	0306740.1	2SC1845 F.E	F-2770 2A 4B
TR02	0306740.1	2SC1845 F.E	2A 4B
TR03	0301090.1	2SA992 F.E	2A 4B
TR04	0306360.1	2SC1951 1.2	2A 4B
TR05	0306740.1	2SC1845 F.E	2B 4A
TR06	0306740.1	2SC1845 F.E	1B 2A
TR07	0306740.1	2SC1845 F.E	2B 4A
TR08	0306740.1	2SC1845 F.F	1B 3A
TR09	0301090.1	2SA992 F.E	2A 4B
TR10	0301090.1	2SA992 F.E	1A 3B
TR11	0301090.1	2SA992 F.E	2A 4B
TR12	0301090.1	2SA992 F.E	1A 3B
TR13	0300760.2	2SA917 1.2	1B 3A
TR14	0306360.1	2SC1951 1.2	1A 3B
TR15	0306740.1	2SC1845 F.E	1B 3A
TR16	0301090.1	2SA992 F.E	1A 3B
TR17	0308501.2	2SD357 D.E	1B 3A
TR18	0303331.2	2SB527 D.E	1A 3B
•FET			
FET01	0370321	2SK131 L.M	2A 4B
•Diode			
D 01	0310480	SV03	2A 4B
D 02	0310480	SV03	2B 4A
D 03	0310480	SV03	1B 3A
•Zener Diode			
ZD01	0316570	RD33E B	2B 4A
C 01	0622151	150pF 125V P.C	2A 4B
C 02	0623200	20pF 125V P.C	2A 4B
C 03	0681014	0.047uF 400V M.C	2A 4B
C 05	0681014	0.047uF 400V M.C	2B 4A
C 07	0622362	3600pF 125V P.C	2B 4A
C 09	0623300	30pF 125V P.C	1B 3A
C 10	0623300	30pF 125V P.C	1A 3B
C 11	0681014	0.047uF 400V M.C	1B 3A
C 13	0622102	1000pF 125V P.C	1B 3A
C 14	0622102	1000pF 125V P.C	1A 3B
C 15	0623200	20pF 125V P.C	1B 3A
C 16	0623200	20pF 125V P.C	1A 3B
C 19	0681001	0.47uF 250V M.C	2B 4A
C 20	0681001	0.47uF 250V M.C	2A 4B
C 23	0681001	0.47uF 250V M.C	1B 3A
C 24	0622332	3300pF 125V P.C	2B 4A
C 25	0682037	0.12uF 100V M.C	2A 4B
C 26	0682023	0.033uF 100V M.C	2A 4B
C 27	0622202	2000pF 125V P.C	2B 4A
R 01	0280563	56kΩ 1/3W C.R	2A 4B
R 02	0280330	33Ω 1/3W C.R	2A 4B
R 03	0210182	1.8kΩ 1/2W N.I.R	2A 4B
R 04	0280333	33kΩ 1/3W C.R	1A 3B
R 05	0280564	560Ω 1/3W C.R	1A 3B
R 06	0280103	10kΩ 1/3W C.R	2A 4B
R 07	0231182	1.8kΩ 1/2W M.R	2B 4A
R 08	0231182	1.8kΩ 1/2W M.R	2B 4A
R 09	0280470	47Ω 1/3W C.R	2B 4A
R 10	0210102	1kΩ 1/2W N.I.R	2B 4A
R 11	0280393	39kΩ 1/3W C.R	2A 4B
R 12	0280821	820Ω 1/3W C.R	1B 3A
R 13	0280101	100Ω 1/3W C.R	2B 4A
R 14	0280821	820Ω 1/3W C.R	1B 3A
R 15	0280101	100Ω 1/3W C.R	2B 4A
R 16	0280101	100Ω 1/3W C.R	1B 3A
R 17	0280151	150Ω 1/3W C.R	1B 3A
R 18	0280151	150Ω 1/3W C.R	1B 3A
R 20	0280330	33Ω 1/3W C.R	1A 3B
R 21	0280151	150Ω 1/3W C.R	1A 3B
R 23	0280151	150Ω 1/3W C.R	1A 3B
R 24	0280101	100Ω 1/3W C.R	2A 4B
R 25	0280101	100Ω 1/3W C.R	1A 3B
R 26	0280821	820Ω 1/3W C.R	2A 4B
R 27	0280101	100Ω 1/3W C.R	1A 3B
R 28	0280821	820Ω 1/3W C.R	1A 3B
R 29	0280121	120Ω 1/3W C.R	1B 3A
R 30	0280393	39kΩ 1/3W C.R	2B 4A
R 31	0280393	39kΩ 1/3W C.R	1A 3B
R 32	0280121	120Ω 1/3W C.R	1A 3B
R 33	0280121	120Ω 1/3W C.R	1A 3B
R 34	0280391	390Ω 1/3W C.R	1B 3A
R 35	0280391	390Ω 1/3W C.R	1A 3B
R 36	0280331	330Ω 1/3W C.R	1B 3A
R 37	0280331	330Ω 1/3W C.R	1A 3B
R 38	0280180	18Ω 1/3W C.R	1B 3A
R 39	0280180	18Ω 1/3W C.R	1A 3B
R 40	0280561	560Ω 1/3W C.R	2B 4A
R 41	0280104	100kΩ 1/3W C.R	2B 4A
R 42	0280330	33Ω 1/3W C.R	2A 4B
R 43	0280229	2.2Ω 1/3W C.R	2A 4B
R 44	0231203	20kΩ 1/2W M.R	2B 4A
R 45	0231642	6.8kΩ 1/2W M.R	2B 4A
R 46	0231182	1.8kΩ 1/2W M.R	2A 4B
R 47	0231391	390Ω 1/2W M.R	2A 4B
R 48	0280330	33Ω 1/3W C.R	1A 3B
VR01	1033890	470Ω B Center DC 0V Adj	2B 4A

3-5. F-2819 Flat Amp Circuit Board (Stock No. 7562781)

Conductor Side

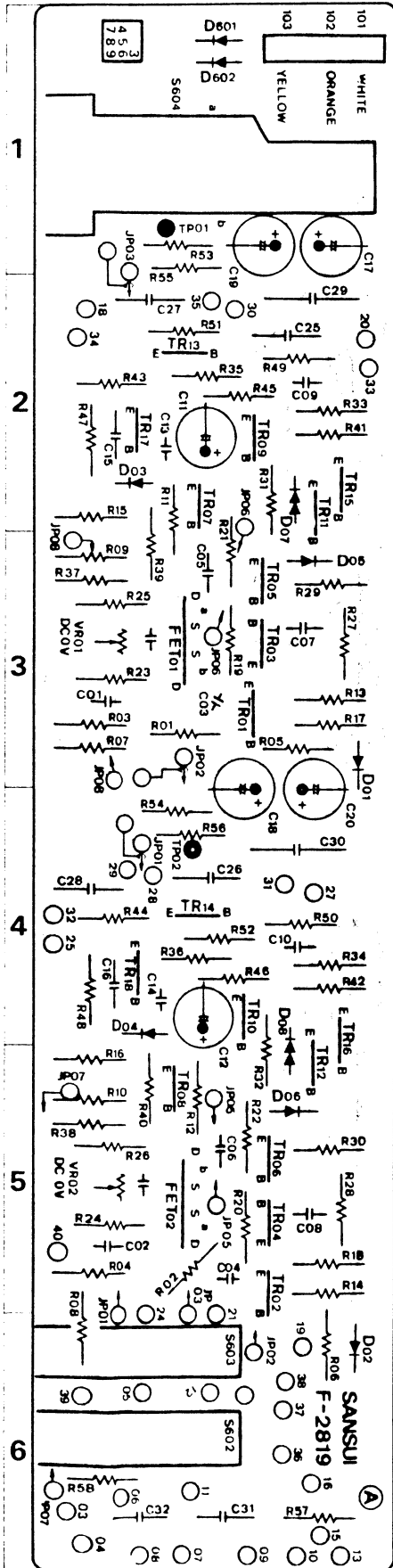

Parts List

Parts No.	Stock No.	Description	Position	Parts No.	Stock No.	Description	Position
•Transistor							
TR01, 02	0301090	2SA692 F, E	3, 5	R 07, 08	0280104	100kΩ 1/3W C.R.	3, 6
TR03, 04	0306740, 1	2SC1845 F, E	3, 5	R 09, 10	0280823	82kΩ 1/3W C.R.	3, 5
TR05, 06	0306740, 1	2SC1845 F, E	3, 5	R 13, 14	0280562	5.6kΩ 1/3W C.R.	3, 5
TR07, 08	0306740	2SC1845 F, E	2, 5	R 15, 16	0280821	820Ω 1/3W C.R.	2, 5
TR09, 10	0301090, 1	2SA982 F, E	2, 4	R 17, 18	0280222	2.2kΩ 1/3W C.R.	3, 5
TR11, 12	0300760, 1	2SA917-1, 2	2, 5	R 19, 20	0280102	1kΩ 1/3W C.R.	3, 5
TR13, 14	0306360, 1	2SC1951-1	2, 4	R 21, 22	0280103	10kΩ 1/3W C.R.	3, 5
TR15, 16	0306360, 1	2SC1951-1, 2	2, 4	R 23, 24	0280470	47Ω 1/3W C.R.	3, 5
TR17, 18	0300760, 1	2SA917-1, 2	2, 4	R 25, 26	0280470	47Ω 1/3W C.R.	3, 5
				R 27, 28	0280152	1.5kΩ 1/3W C.R.	3, 5
				R 29, 30	0280222	2.2kΩ 1/3W C.R.	3, 5
				R 31, 32	0280331	330Ω 1/3W C.R.	2, 5
				R 33, 34	0280222	2.2kΩ 1/3W C.R.	2, 4
				R 35, 36	0280222	2.2kΩ 1/3W C.R.	2, 4
				R 37, 38	0280272	2.7kΩ 1/3W C.R.	3, 5
				R 39, 40	0280272	2.7kΩ 1/3W C.R.	3, 5
				R 41, 42	0280681	680Ω 1/3W C.R.	2, 4
				R 43, 44	0280681	680Ω 1/3W C.R.	2, 4
				R 45, 46	0280151	150Ω 1/3W C.R.	2, 4
				R 47, 48	0280822	8.2kΩ 1/3W C.R.	2, 4
				R 49, 50	0280820	82Ω 1/3W C.R.	2, 4
				R 51, 52	0280820	82Ω 1/3W C.R.	2, 4
				R 53, 54	0280154	150kΩ 1/3W C.R.	1, 4
				R 55, 56	0280221	220Ω 1/3W C.R.	1, 4
				R 57, 58	0280824	820kΩ 1/3W C.R.	6
				R 59 ~ 62	0280224	220kΩ 1/3W C.R.	6
				VR01, 02	1034150	100Ω B Center DC 0V Adj	3, 5
				S 602	1131R10	Jump & Subsonic Filter Switch	6
				S 604	1190640	Speakers Switch	1
				R 01, 02	0280101	100Ω 1/3W C.R.	3, 5
				R 03, 04	0280823	82kΩ 1/3W C.R.	3, 5

3-6. F-2773 Muting Circuit Board (Stock No. 7597401)

Conductor Side

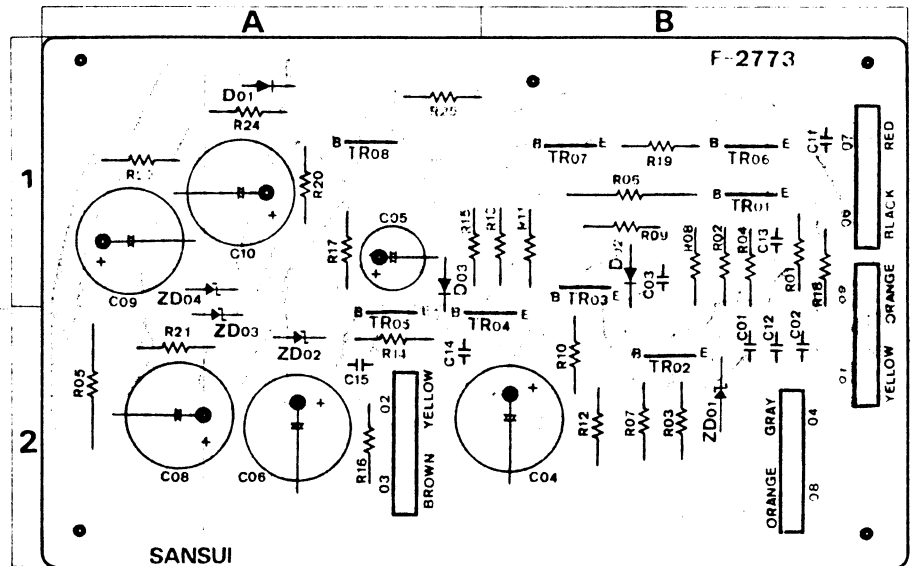

Parts List

Parts No.	Stock No.	Description	Position	Parts No.	Stock No.	Description	Position
•Transistor							
TR01	0305951, 2	2SC945 O, P	1B	R 03	0280101	100Ω 1/3W C.R.	2B
TR02	0305951, 2	2SC945 O, P	2B	R 04	0280472	4.7kΩ 1/3W C.R.	1B
TR03	0305951, 2	2SC945 O, P	1B	R 05	0212220	22Ω 2W N.I.R.	2A
TR04	0305951, 2	2SC945 O, P	2B	R 06	0212152	1.5kΩ 2W N.I.R.	1B
TR05	0305951, 2	2SC945 O, P	2A	R 07	0280333	33kΩ 1/3W C.R.	2B
TR06	0305951, 2	2SC945 O, P	1B	R 08	0280473	4.7kΩ 1/3W C.R.	1B
TR07	0305951, 2	2SC945 O, P	1B	R 09	0280472	4.7kΩ 1/3W C.R.	1B
TR08	0305951, 2	2SC945 O, P	1A	R 10	0280471	4.7kΩ 1/3W C.R.	2B
				H 11	0280184	184Ω 1/3W C.R.	1B
				H 12	0280223	2.2kΩ 1/3W C.R.	2B
				H 13	0280222	2.2kΩ 1/3W C.R.	1B
				H 14	0280682	6.8kΩ 1/3W C.R.	2A
				H 15	0280223	2.2kΩ 1/3W C.R.	1A
				H 16	0280273	2.7kΩ 1/3W C.R.	2A
				H 17	0280222	2.2kΩ 1/3W C.R.	1A
				H 18	0280101	100Ω 1/3W C.R.	1B
				H 19	0280221	220Ω 1/3W C.R.	1B
				H 20	0280471	4.7kΩ 1/3W C.R.	1A
				H 21	0280123	1.2kΩ 1/3W C.R.	2A
				H 22	0280153	15kΩ 1/3W C.R.	1A
				H 23	0280101	100Ω 1/3W C.R.	1A
				R 24	0280472	4.7kΩ 1/3W C.R.	1A
				R 25	0280101	100Ω 1/3W C.R.	1A
				R 01	0280101	100Ω 1/3W C.R.	1B
				R 02	0280471	4.7kΩ 1/3W C.R.	1B
				ZD01	0316520	RD24E C	2B
				ZD02	0316290	RD12E B	2A
				ZD03	0316520	RD24E C	2A
				ZD04	0316520	RD24E C	1A

3-7. F-2775 Driver Amp Circuit Board (Stock No. 7572191)

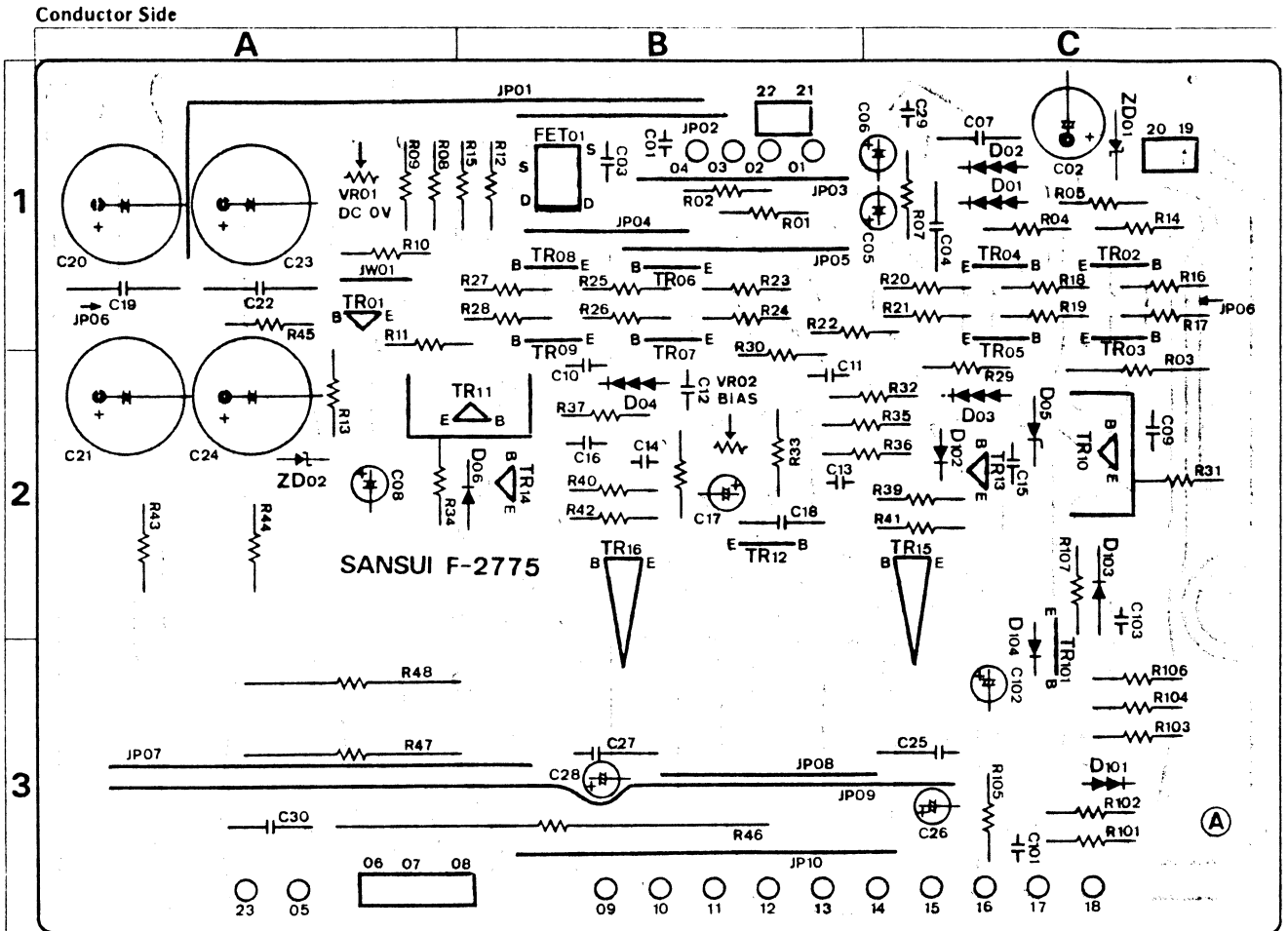

Parts List

Parts No.	Stock No.	Description	Position	Parts No.	Stock No.	Description	Position	Parts No.	Stock No.	Description	Position
•Transistor											
TR01	0306680	1 2SC2071 B, V	1A	C 04	0681013	0.033µF 400V M.C.	1C	R 23	0280121	120Ω 1/3W C.R.	1B
TR02	0306740	1 2SC1845 F, E	1C	C 07	0681013	0.033µF 400V M.C.	1C	R 24	0280121	120Ω 1/3W C.R.	1B
TR03	0306740	1 2SC1845 F, E	1C	C 09	0623309	3pF 125V P.C.	2C	R 25	0280101	100Ω 1/3W C.R.	1B
TR04	0306740	1 2SC1845 F, E	1C	C 10	0623309	3pF 125V P.C.	2B	R 26	0280101	100Ω 1/3W C.R.	1B
TR05	0306740	1 2SC1845 F, E	1C	C 11	0623109	1pF 125V P.C.	2B	R 27	0280821	820Ω 1/3W C.R.	1B
TR06	0301090	1 2SA992 F, E	1B	C 12	0623109	1pF 125V P.C.	2B	R 28	0280821	820Ω 1/3W C.R.	1B
TR07	0301090	1 2SA992 F, E	1B	C 13	0622102	1000pF 125V P.C.	2B	R 29	0280393	39kΩ 1/3W C.R.	2C
TR08	0301090	1 2SA992 F, E	1B	C 14	0622102	1000pF 125V P.C.	2B	R 30	0280393	39kΩ 1/3W C.R.	2C
TR09	0301090	1 2SA992 F, E	1B	C 15	0623330	33pF 125V P.C.	2C	R 31	0280151	150Ω 1/3W C.R.	2C
TR10	0301030	1 2SA939 B, V	2C	C 16	0623330	33pF 125V P.C.	2B	R 32	0280472	47kΩ 1/3W C.R.	2C
TR11	0306680	1 2SC2071 B, V	2B	C 18	0681013	0.033µF 400V M.C.	2B	R 33	0280681	680Ω 1/3W C.R.	2C
TR12	0306740	1 2SC1845 F, E	2B	C 19	0681018	0.22µF 400V M.C.	1A	R 34	0280151	150Ω 1/3W C.R.	2A
TR13	0306680	1 2SC2071 B, V	2B	C 22	0681018	0.22µF 400V M.C.	1A	R 35	0280560	56Ω 1/3W C.R.	2C
TR14	0301030	1 2SA939 B, V	2B	C 29	0622681	680pF 125V P.C.	1C	R 36	0280391	390Ω 1/3W C.R.	2C
TR15	0306660	1 2SC2238LB O, Y	2C	C 30	0681014	0.47µF 400V M.C.	3A	R 37	0280391	390Ω 1/3W C.R.	2B
TR16	0301020	1 2SA968LB O, Y	2B					R 38	0280103	10kΩ 1/3W C.R.	2C
TR101	0306740	1 2SC1845 F, E	3C					R 39	0210561	560Ω 1/2W N.I.R.	2C
•FET											
FET01	0370251	1 2SK97	1B	R 01	0280104	100kΩ 1/3W C.R.	1B	R 40	0210561	560Ω 1/2W N.I.R.	2C
•Diode											
D 01	0310480	SV03	1C	R 02	0280681	680Ω 1/3W C.R.	1B	R 41	0210470	47Ω 1/2W N.I.R.	2C
D 02	0310480	SV03	1C	R 03	0212272	2.7kΩ 2W N.I.R.	2C	R 42	0210470	47Ω 1/2W N.I.R.	2B
D 03	0310480	SV03	2C	R 04	0231392	3.9kΩ 1/2W C.R.	1C	R 43	0210120	12Ω 1/2W N.I.R.	2A
D 04	0310480	SV03	2B	R 05	0231392	3.9kΩ 1/2W C.R.	1C	R 44	0210120	12Ω 1/2W N.I.R.	2A
D 05	0310340	10D1	2C	R 07	0280471	470Ω 1/3W C.R.	1C	R 45	0280273	27kΩ 1/3W C.R.	1A
D 06	0310340	10D1	2B	R 08	0280470	47Ω 1/3W C.R.	1A	R 46	0207100	10Ω 7W N.I.R.	3B
D 101	0340150	MV12	3C	R 09	0280470	47Ω 1/3W C.R.	1A	R 47	0213392	3.9kΩ 3W N.I.R.	3A
D 102	0311160	1S2473D	2C	R 10	0280470	47Ω 1/3W C.R.	1A	R 48	0213392	3.9kΩ 3W N.I.R.	3A
D 103	0310400	1N34A	2C	R 11	0280152	15kΩ 1/3W C.R.	1A	R 101	0280104	100kΩ 1/3W C.R.	3C
D 104	0311160	1S2473D	2C	R 12	0280331	330Ω 1/3W C.R.	1B	R 102	0280223	22kΩ 1/3W C.R.	3C
•Zener Diode											
ZD01	0317190	RD27E (B)	1C	R 13	0280392	39kΩ 1/3W C.R.	2A	R 103	0280680	68Ω 1/3W C.R.	3C
ZD02	0316310	RD14E (B)	2A	R 14	0280101	100Ω 1/3W C.R.	1C	R 104	0280393	39kΩ 1/3W C.R.	3C
C 01	0622101	100µF 125V P.C.	1B	R 15	0280101	100Ω 1/3W C.R.	1B	R 105	0280272	2.2kΩ 1/3W C.R.	3C
C 03	0623220	22µF 125V P.C.	1B	R 16	0280821	820Ω 1/3W C.H.	1C	R 106	0280623	82kΩ 1/3W C.R.	3C
				R 17	0280821	820Ω 1/3W C.H.	1C	R 107	0280822	8.2kΩ 1/3W C.R.	2C
				R 18	0280101	100Ω 1/3W C.R.	1C				
				R 19	0280101	100Ω 1/3W C.R.	1C	VR01	1033570	100Ω B 2.5x2 Center DC OV Adj.	1A
				R 20	0280121	120Ω 1/3W C.H.	1C	VR02	1033630	1kΩ B 2.5x2 Bias Current Adj.	2B
				R 21	0280121	120Ω 1/3W C.H.	1C				
				R 22	0280820	82Ω 1/3W C.H.	1B				

3-8. F-2781 Power Supply & Protector Circuit Board (Stock No. 7503261)

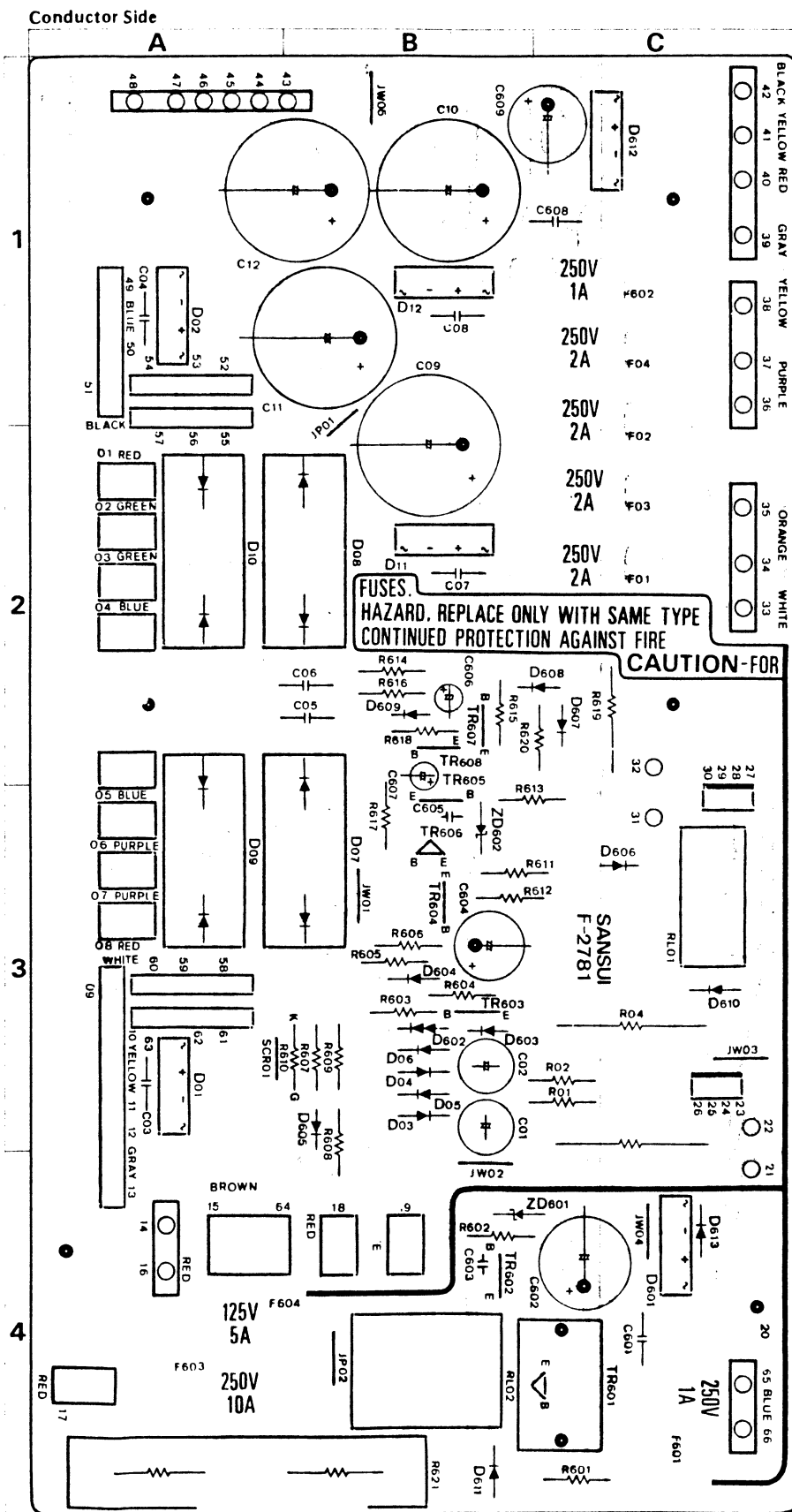

Parts List

Parts No.	Stock No.	Description	Position
•Transistor			
TR601	0308611.2	2SD357 D.E	4C
TR602	0305951.2	2SC945 O.P	4B
TR603	0305951.2	2SC945 O.P	3B
TR604	0305951.2	2SC945 O.P	3B
TR605	0305951.2	2SC945 O.P	3B
TR606	0308611.2	2SD357 D.E	3B
TR607	0305951.2	2SC945 O.P	2B
TR608	0305951.2	2SC945 O.P	2B
•Diode			
D 01, 02	0311700	RB152	3A, 1A
D 03, 04	0311160	1S2473D	3B
D 05, 06	0311160	1S2473D	3B
D 07, 08	0311310	SS5	3B, 2B
D 09, 10	0211320	SS5R	3A, 2A
D 11	0311700	RB152	2B
D 12	0311700	RB152	1B
D 601	0311700	RB152	4C
D 602	0340150	MV12	3B
D 603	0311160	1S2473D	3B
D 604	0311160	1S2473D	3B
D 605	0311160	1S2473D	3B
D 606	0311160	1S2473D	3C
D 607	0311160	1S2473D	2C
D 608	0311160	1S2473D	2C
D 609	0311160	1S2473D	2B
D 610	0310340	10D1	3C
D 611	0310340	10D1	4B
D 612	0311700	RB152	1C
D 613	0310340	10D1	4C
•Zener Diode			
ZD601	0316510	RD24E B	4B
ZD602	0316390	RD6.2E B	3B
•SCR			
SCR601	0350020	2SF656	
C 03, 04	060610R	0.1µF 250V M.C	3A, 1A
C 05, 06	060610R	0.1µF 250V M.C	2B
C 07	060610R	0.1µF 250V M.C	2B
C 08	060610R	0.1µF 250V M.C	1B
C 09	0548001	4700µF 25V E.C	2B
C 10	0548001	4700µF 25V E.C	1B
C 11	0548001	4700µF 25V E.C	1B
C 12	0548001	4700µF 25V E.C	1A
C 601	060610R	0.1µF 250V M.C	4C
C 608	060610R	0.1µF 250V M.C	1C
R 01, 02	0280223	22kΩ 1/3W C.R	3C
R 03, 04	0135221	220kΩ 5W Ce.R	3C
R 601	0210829	8.2kΩ 1W N.I.R	4C
R 602	0210102	1kΩ 1/2W N.I.R	4B
R 603	0280474	470kΩ 1/3W C.R	3B
R 604	0280334	330kΩ 1/3W C.R	3B
R 605	0280104	100kΩ 1/3W C.R	3B
R 606	0280393	39kΩ 1/3W C.R	3B
R 607	0280330	33kΩ 1/3W C.R	3B
R 608	0280472	47kΩ 1/3W C.R	3B
R 609	0280163	16kΩ 1/3W C.R	3B
R 610	0280102	1kΩ 1/3W C.R	3B
R 611	0280330	33kΩ 1/3W C.R	3B
R 612	0280330	33kΩ 1/3W C.R	3B
R 613	0280473	47kΩ 1/3W C.R	3B, C
R 614	0280682	6.8kΩ 1/3W C.R	2B
R 615	0280474	470kΩ 1/3W C.R	2B
R 616	0280104	100kΩ 1/3W C.R	2B
R 617	0280104	100kΩ 1/3W C.R	3B
R 618	0280474	470kΩ 1/3W C.R	2B
R 619	0212152	15kΩ 2W N.I.R	2C
R 620	0280121	120kΩ 1/3W C.R	2C
R 621	0159160	3.9kΩ 20W Ce.R	4B
RL01	1150430	Relay	3C
RL02	1150360	Relay	4B
F 01	0432240	AC Fuse 2A 250V	2C
F 02	0432240	AC Fuse 2A 250V	2C
F 03	0432240	AC Fuse 2A 250V	2C
F 04	0432240	AC Fuse 2A 250V	1C
F 601	0432240	AC Fuse 1A 250V	4C
F 602	0432220	AC Fuse 1A 250V	1C
F 603	0431320	AC Fuse 10A 250V	4A
F 604	0433290	AC Fuse 5A 125V	4A, B

3-9. F-2778 Regulated Power Supply Circuit Board (Stock No. 7503271)

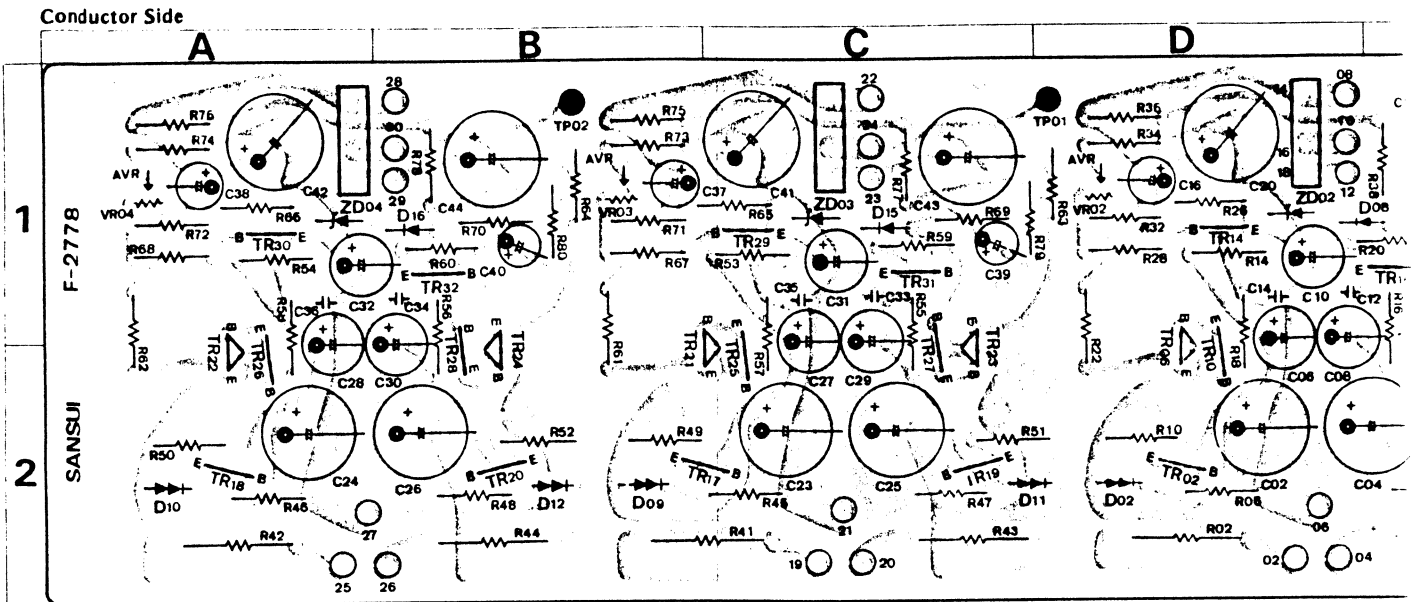

Parts List

Parts No.	Stock No.	Description	Position	Parts No.	Stock No.	Description	Position	Parts No.	Stock No.	Description	Position
•Transistor											
TR01, 02	0301090, 1	2SA992 F, E	2E, 2D	D 03, 04	0340120	VD1212	2F, 2E	R 07, 08	0280333	33kΩ 1/3W C.R.	2F, 2E
TR03, 04	0306740, 1	2SC1845 F, E	2F, 2E	D 07, 08	0311160	1S2473D	1F, 1E	R 09, 10	0191331	330Ω 1/4W F.R.	2E, 2D
TR05, 06	0306611, 2	2SC357 D, E	2E, 2D	D 09, 10	0340120	VD1212	2B, 2A	R 11, 12	0191331	330Ω 1/4W F.R.	2F, 2E
TR07, 08	0303441, 2	2SB527 D, E	2E, 2D	D 11, 12	0340120	VD1212	2C, D, 2B	R 13, 14	0280472	47kΩ 1/3W C.R.	1F, 1D
TR09, 10	0306740, 1	2SC1845 F, E	2E, 2D	D 15, 16	0311160	1S2473D	1C, 1B	R 15, 16	0280472	47kΩ 1/3W C.R.	1F, 1E
TR11, 12	0301090, 1	2SA992 F, E	2F, 2E	D 604	0310340	10D1		R 17, 18	0280221	220Ω 1/4W C.R.	1F, 1D
TR13, 14	0306740, 1	2SC1845 F, E	1F, 1D	D 605	0310340	10D1		R 19, 20	0280221	220Ω 1/4W C.R.	1F, 1E
TR15, 16	0301090, 1	2SA992 F, E	1F, 1E					R 21, 22	0192479	47Ω 1/2W F.R.	1E, 1D
TR17, 18	0301090, 1	2SA992 F, E	2C, 2E					R 25, 26	0280622	6.8kΩ 1/3W C.R.	1E, 1D
TR19, 20	0306740, 1	2SC1845 F, E	2C, 2B					R 27, 28	0280102	1kΩ 1/3W C.R.	1E, 1D
TR21, 22	0306611, 2	2SD357 D, E	2C, 2A					R 29, 30	0280102	1kΩ 1/3W C.R.	1F, 1E
TR23, 24	0303441, 2	2SB527 D, E	2C, 2B	C 01, 02	0587331	330μF 80V E.C.	2F, 2D	R 31, 32	0280103	10kΩ 1/3W C.R.	1E, 1D
TR25, 26	0306740, 1	2SC1845 F, E	2C, 2A	C 03, 04	0587331	330μF 80V E.C.	2F, 2E	R 33, 34	0280622	8.2kΩ 1/3W C.R.	1E, 1D
TR27, 28	0301090, 1	2SA992 F, E	2C, 2B	C 05, 06	0587470	47μF 80V E.C.	1, 2F, 1, 2D	R 35, 36	0280181	180Ω 1/3W C.R.	1F, 1E
TR29, 30	0306740, 1	2SC1845 F, E	1C, 1A	C 07, 08	0587470	47μF 80V E.C.	1, 2F, 1, 2D	R 37, 38	0280183	18kΩ 1/3W C.R.	1F, 1E
TR31, 32	0301090, 1	2SA992 F, E	1C, 1B					R 39, 40	0280183	18kΩ 1/3W C.R.	1F, 1E
•Diode											
D 01, 02	0340120	VD1212	2E, 2D	R 01, 02	0212101	100Ω 2W N.I.R.	2E, 2D	R 41, 42	0212120	12Ω 2W N.I.R.	2C, 2B
				R 03, 04	0212101	100Ω 2W N.I.R.	2F, 2E	R 43, 44	0212120	12Ω 2W N.I.R.	2C, 2A
				R 05, 06	0280333	33kΩ 1/3W C.R.	2E, 2D	R 45, 46	0280682	6.8kΩ 1/3W C.R.	2C, 2A
								R 47, 48	0280682	6.8kΩ 1/3W C.R.	2C, 2B

• Note: The circuit boards, F-2820, F-2772, F-2774, F-2776, F-2777 are not supplied as the assembled, the individual parts on the circuit board, however, are provided for orders.

3-10. F-2774 Buffer Amp Circuit Board

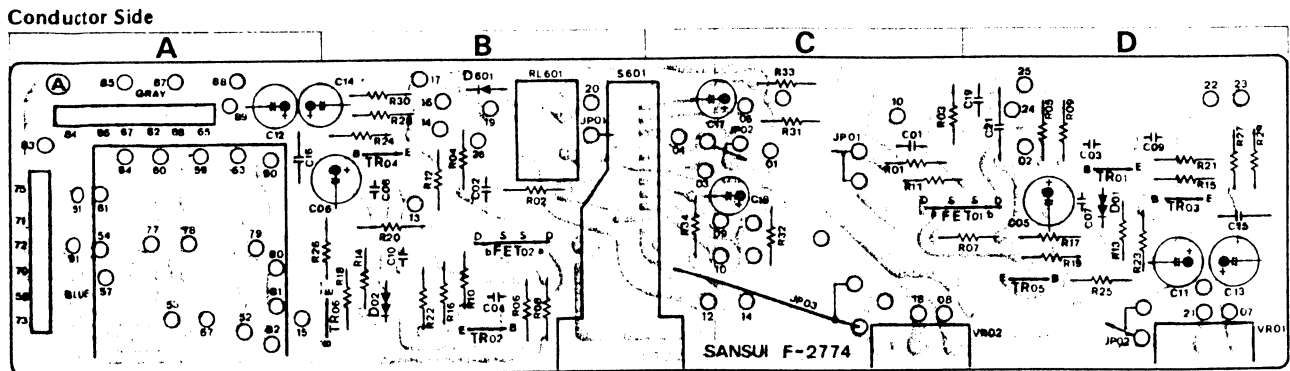

Parts List

Parts No.	Stock No.	Description	Position
R 31 ~ 34	0280474	470kΩ 1/3W C.R.	C
RL601	1150620	Relay	B
VR01, 02	1000360	50kΩ A	C, D
S 601	1190640	Power Amp Operation Switch	B
S 602	1104400	Tape Copy Switch	

Abbreviations

C.R.	: Carbon Resistor	E.C.	: Electrolytic Capacitor
S.R.	: Solid Resistor	BP.E.C.	: Bi-Polar Electrolytic Capacitor
Ce.R.	: Cement Resistor	C.C.	: Ceramic Capacitor
M.R.	: Metal Film Resistor	Mi.C.	: Mica Capacitor
F.R.	: Fusing Resistor	O.C.	: Oil Capacitor
N.I.R.	: Non-Inflammable Resistor	P.C.	: Polystyrene Capacitor
M.C.	: Mylar Capacitor	T.C.	: Tantalum Capacitor

3-11. F-2820 Speakers Relay Circuit Board

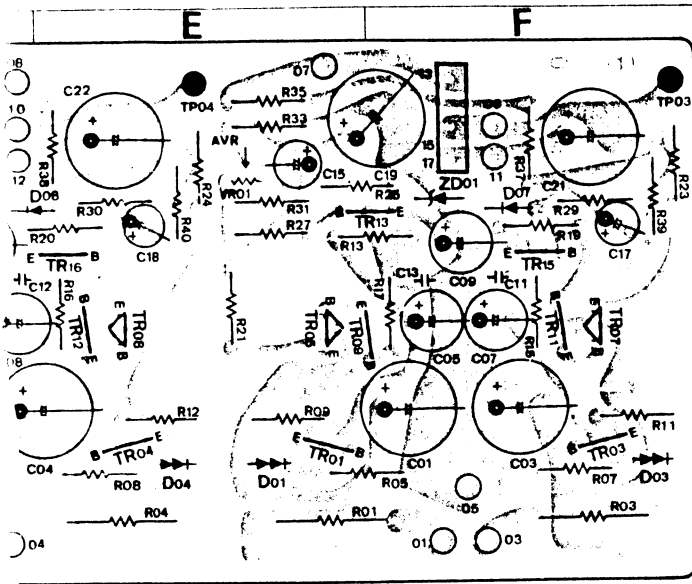

Parts List

Parts No.	Stock No.	Description	Position
R 49, 50	0280471	470Ω 1/3W C.R.	2B, 2A
R 51, 52	0280471	470Ω 1/3W C.R.	2C, 2B
R 53, 54	0280122	1.2kΩ 1/3W C.R.	1C, 1A
R 55, 56	0280122	1.2kΩ 1/3W C.R.	1C, 1B
R 57, 58	0280221	220Ω 1/3W C.R.	1, 2C, 1A
R 59, 60	0280221	220Ω 1/3W C.R.	1C, 1B
R 61, 62	0192229	2.2Ω 1/2W F.R.	1B, 1A
P 65, 66	0280561	560Ω 1/3W C.R.	1C, 1A
R 67, 68	0280102	1kΩ 1/2W C.R.	1B, 1A
R 69, 70	0280102	1kΩ 1/2W C.R.	1C, 1B
R 71, 72	0280392	3.9kΩ 1/3W C.R.	1B, 1A
R 73, 74	0280562	5.6kΩ 1/3W C.R.	1B, 1A
R 75, 76	0280103	10kΩ 1/3W C.R.	1B, 1A
R 77, 78	0280102	1kΩ 1/3W C.R.	1C, 1B
VR01, 02	1033670	4.7kΩ B DC Volt Adj.	1E, 1D
VR03, 04	1033650	2.2kΩ B DC Volt Adj.	1B, 1A

Conductor Side

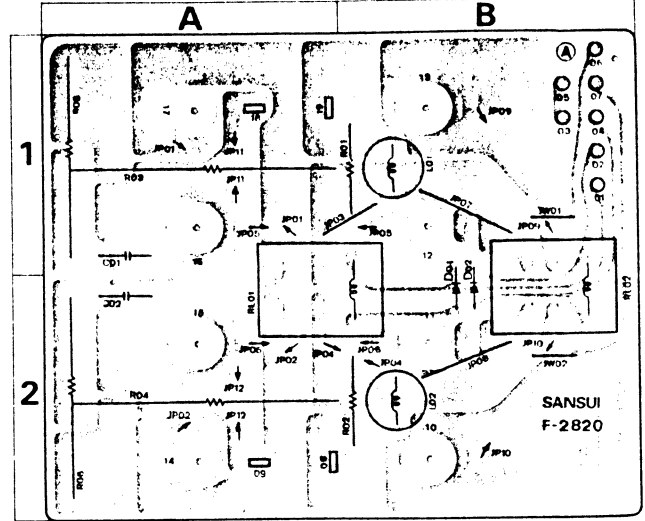

Parts List

Parts No.	Stock No.	Description	Position
•Diode			
D 01, 02	0310340	10D1	2B
C 01, 02	0681014	0.047μF 400V M.C.	1A, 2A
R 01, 02	0212109	1Ω 2W N.I.R.	1B, 2B
R 03, 04	0207100	10Ω 7W N.I.R.	1A, 2A
L 01, 02	4290370	RF Coil 1μH	1B, 2B
RL01, 02	1150410	Relay	2A, 2B

3-12. F-2777 MC, MM Switch Circuit Board

Conductor Side
SANSUI_F-2777

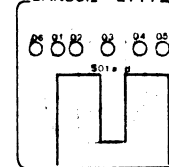

Parts List

Parts No.	Stock No.	Description
S 01	1131800	MM/MC Switch

3-13. F-2772 MC, MM Mother Circuit Board

Conductor Side

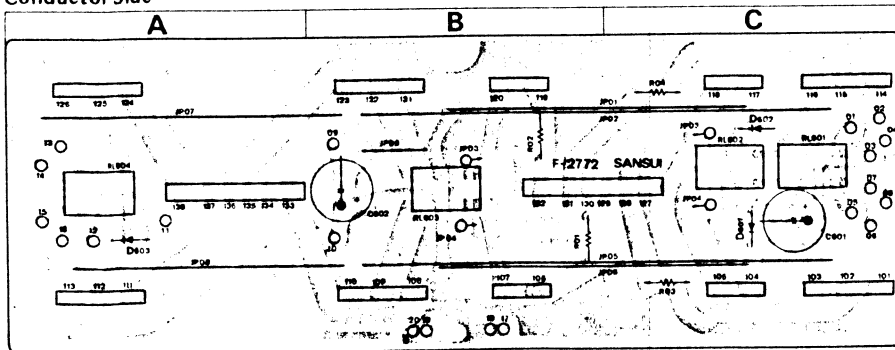

Parts List

Parts No.	Stock No.	Description	Position
•Diode			
D601 - 603	0310340	10D1	A, C
C 601	0504471	470μF 35V E.C.	C
C 602	0504471	470μF 35V E.C.	B
RL601-604	1150620	Relay	A, B, C

3-14. F-2776 Selector Switch Circuit Board

Conductor Side

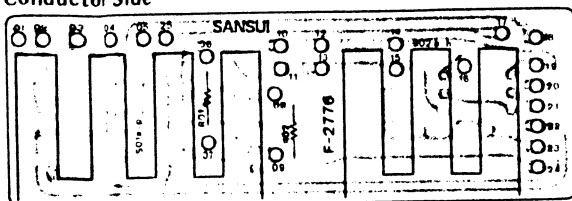

Parts List

Parts No.	Stock No.	Description
S 01	1131830	Selector Switch
S 02	1131820	Tape Play Switch

4. ADJUSTMENTS

- Notes:** 1. Level Volume Minimum
 2. Room Temperature 18°C ~ 28°C
 (65°F ~ 83°F)

3. When replacing some parts or circuit board, refer to description in REMARKS.
 4. For this adjustment, run the unit for more than 3 minutes after the power is switched ON.

4-1. F-2778 Power Supply Voltage Adjustment (See Top View on page 12)

STEP	SUBJECT	MEASURE OUTPUT	ADJUST	ADJUST FOR	REMARKS
1	For MC Head Amp L-CH	Between GND & TP01	VR03 F-2778	-10.5 V	
2	For MC Head Amp R-CH	Between GND & TP02	VR04 F-2778	-10.5 V	
3	For MM Head Amp L-CH	Between GND & TP03	VR01 F-2778	-47.5 V	
4	For MM Head Amp R-CH	Between GND & TP04	VR02 F-2778	-47.5 V	

4-2. F-2775 Driver Circuit Adjustment (See Top View on page 12)

STEP	SUBJECT	MEASURE OUTPUT	ADJUST	ADJUST FOR	REMARKS
1	DC 0V Adj. L-CH	Speaker terminal	VR01 F-2775	DC 0V ± 5 mV	Before turning ON power switch, set VR01 to center position.
2	DC 0V Adj. R-CH	Speaker terminal	VR01 F-2775		
3	Bias current Adj. L-CH	Between emitters of power transistors, TR701 & TR703 (between T.P Pin)	VR02 F-2775	DC 25 mV ± 1 mV	Before turning ON power switch, turn VR02 fully counterclockwise. This bias current adjustment converts current value into voltage by Ohm's law.
4	Bias current Adj. R-CH	Between emitters of power transistors, TR702 & TR704 (between T.P Pin)	VR02 F-2775		

4-3. F-2917, F-2918 MC Head Amp Adjustment (See Top View on page 12)

STEP	SUBJECT	MEASURE OUTPUT	ADJUST	ADJUST FOR	REMARKS
1	DC 0V Adj. L-CH F-2917	Between GND & common joint of emitter resistors R41, R47 (TP01)	VR01 F-2917	DC 0V ± 5 mV	Before turning ON power switch, set VR01 to center position.
2	DC 0V Adj. R-CH F-2918	Same as above	VR01 F-2918		

4-4. F-2770, F-2771 Equalizer Circuit Adjustment (See Top View on page 12)

STEP	SUBJECT	MEASURE OUTPUT	ADJUST	ADJUST FOR	REMARKS
1	DC 0V Adj. L-CH F-2770	Between GND & common joint of emitter resistors R38, R39 (TP01)	VR01 F-2770	DC 0V ± 50 mV	Before turning ON power switch, set VR01 to center position.
2	DC 0V Adj. R-CH F-2771	Same as above	VR01 F-2771		

4-5. F-2819 Flat Amp Circuit Adjustment (See Top View & Bottom View on page 12)

STEP	SUBJECT	MEASURE OUTPUT	ADJUST	ADJUST FOR	REMARKS
1	DC 0V Adj. L-CH	Between chassis and collector connecting point TP01 of TR15 & TR17 (Top View)	VR01 F-2819	DC 0V ± 5 mV	Before turning ON power switch, set VR01 & VR02 to center position.
2	DC 0V Adj. R-CH	Between chassis and collector connecting point TP02 of TR16 & TR18 (Bottom View)	VR02 F-2819		

5. OTHER PARTS

5-1. Top View

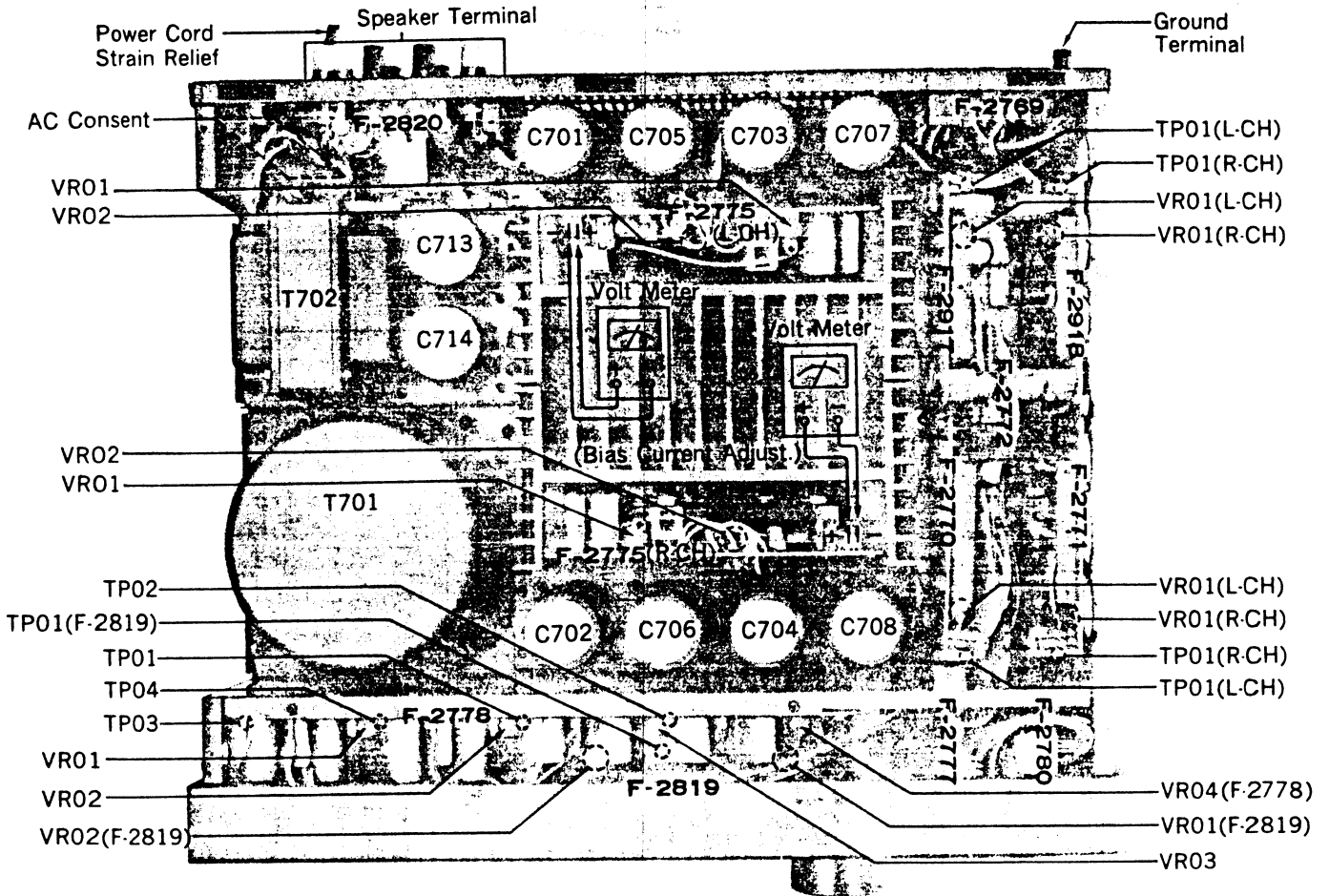

5-2. Front View

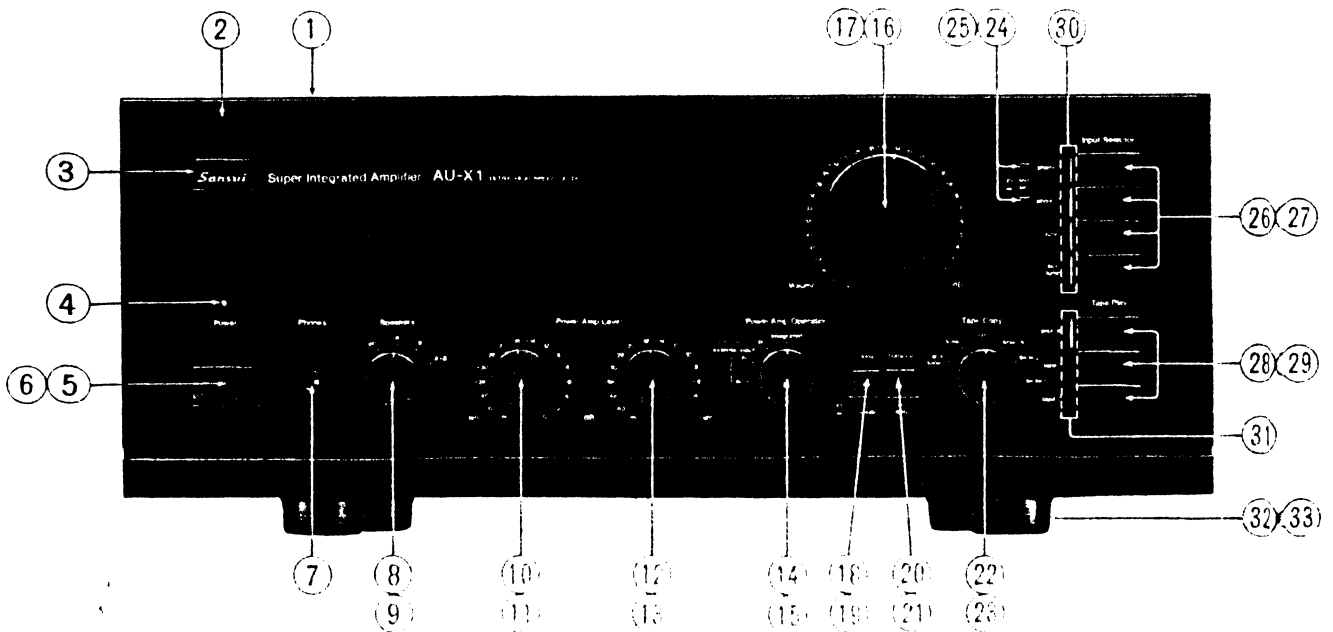

5-3. Bottom View

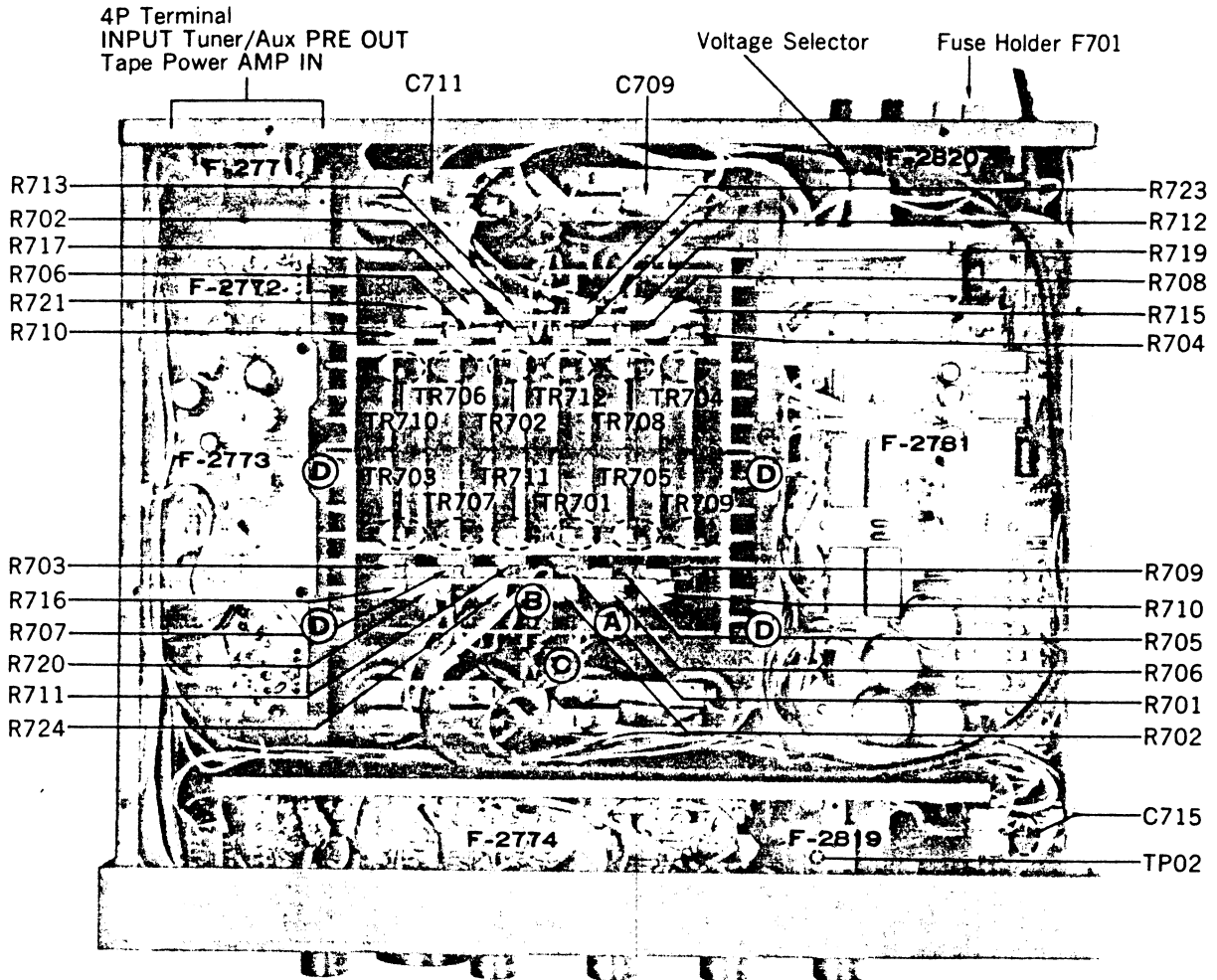

Parts List <Top View, Front View & Bottom View>

Parts No.	Stock No.	Description	Parts No.	Stock No.	Description	Parts No.	Stock No.	Description	
•Transistor			11	5319210	Knob, level volume, Y-7 type		2450070	AC Consent	
TR701, 702	0306890, 1	25C2493 O, Y	12	1000360	Right Level Volume, 50kΩ		2230190	Ground Terminal	
TR703, 704	0301200, 1	25A1068 O, Y	13	5319210	Knob, level volume, Y-7 type		3800490	Power Cord	
TR705, 706	0306890, 1	25C2493 O, Y	14	1190640	Power Amp Operation Switch		3910490	Strain Relief, power cord	
TR707, 708	0301200, 1	25C1068 O, Y	15	5319210	Knob, power amp operation switch		2230220	1P Speaker Terminal (Red)	
TR709, 710	0306890, 1	25C2493 O, Y	16	1090500	Volume, 50kΩ		2230230	1P Speaker Terminal (Black)	
TR711, 712	0301200, 1	25A1068 O, Y	17	5319200	Knob, volume, X-7 type		2200630	4P Input Terminal, phono shorting type	
C701 ~ 708	0559851	10000μF 80V E.C.	18, 20	1131810	Jump, subsonic switch		2200620	4P Input Terminal, aux/tuner, shorting type	
C709 ~ 712	0681033	1μF 250V M.C.	19, 21	5326760	Knob, jump switch		2200650	4P Tape Terminal, non-shorting type	
C 713, 714	0659850	2200μF 100V E.C.	22	1104400	Tape Copy Switch		2200620	4P Power AMP IN Terminal, shorting type	
C 715	0659801	0.01μF 150V C.C.	23	5319210	Knob, tape copy switch, Y-7 type		2200580	4P PRE OUT Terminal, non-shorting type	
R701 ~ 712	0200479	47Ω 1/2W N.I.R.	24	1131800	MM/MC Switch		T701	4002960	Power Transformer
R713 ~ 724	0159130	0.33Ω 5W Ce R.	25	7106150	Knob Ass'y, MM/MC Switch		T702	4002970	Power Transformer
1	5006810	Bonnet	26	1131830	Input Selector Switch		2410091	Voltage Selector, Plug	
2	7008150	Front Panel Ass'y	27	5326750	Knob, input selector switch		2410830	Voltage Selector, Socket	
3	5336600	Sansui Badge	28	1131820	Tape Play Switch		F701	0432290	5A 125V AC 100V, 120V AC
4	0319090	LED	29	5326750	Knob, tape play switch		0434060	10A 250V AC 220V, 240V Fuse	
	5152210	CS Washer	30	5396630	4P Guide Plate Ass'y		2300060	AC Fuse Holder	
	7106150	Knob Ass'y		5426420	Indicator				
5	1131790	Power Switch	31	5396570	3P Guide Plate Ass'y				
6	536740	Knob, power switch, p type		5428240	Indicator				
7	2430290	Phone Jack		5426440	Color Plate				
8	1190640	Speakers Switch		5396580	4P Guide Plate				
9	5319210	Knob, speakers switch, Y-7 type		5059030	3P Guide Plate				
10	1000360	Left Level Volume 50kΩ	32	5059030	Bottom Plate				
			33	6517050	Leg				

A

B

C

D

AU-X1 AU-2

6. SCHEMATIC DIAGRAM 6-1. Pre Amp Section

1

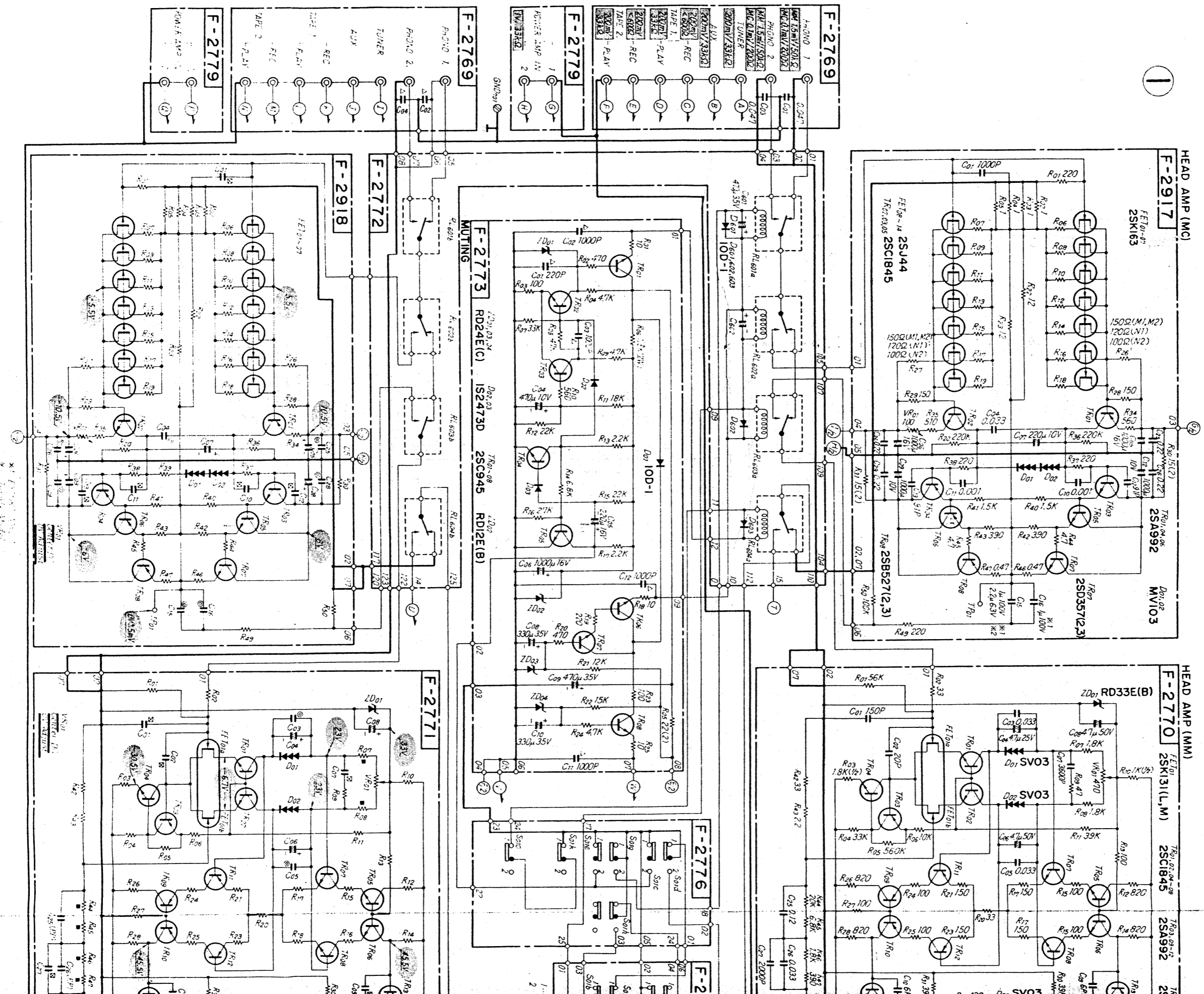

-X1 AU-X1

Design and specifications subject to change without notice for improvement.
 La présentation et les spécifications sont susceptibles d'être modifiées sans préavis par suites d'améliorations éventuelles.
 Änderungen, die dem technischen Fortschritt dienen, bleiben vorbehalten.

E

F

G

H

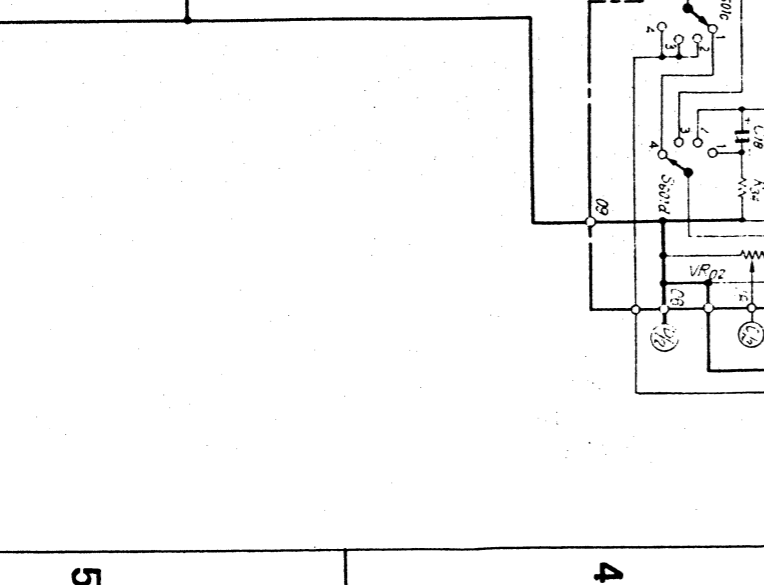
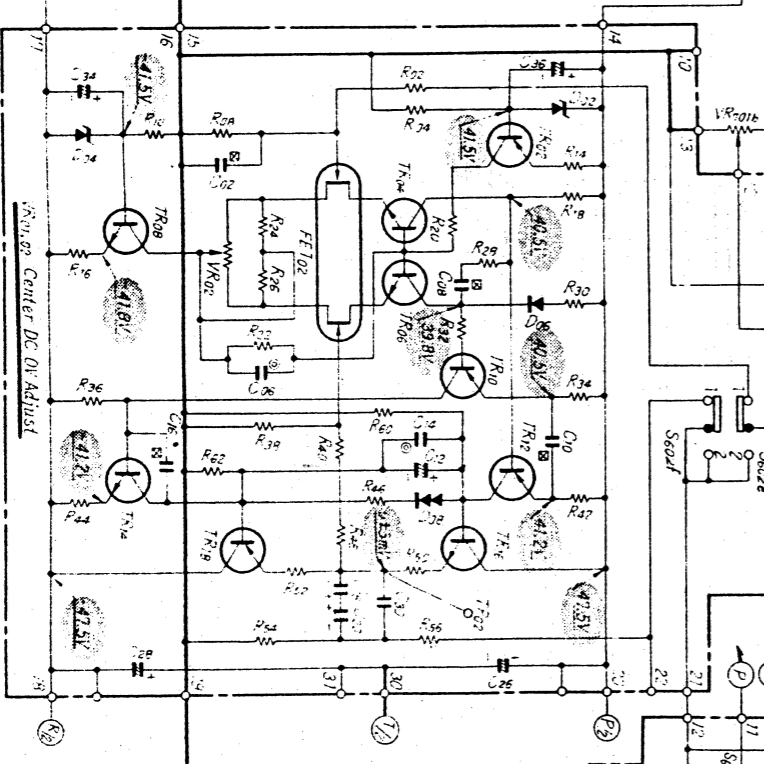
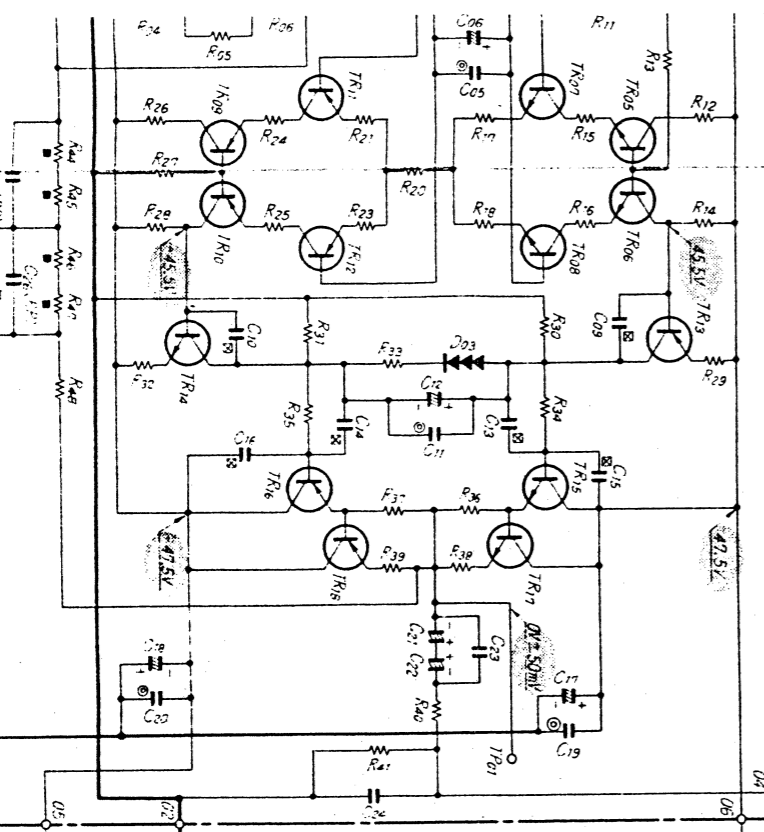
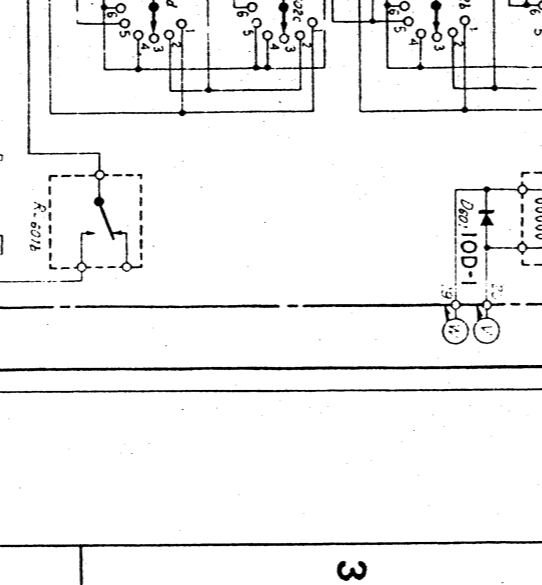
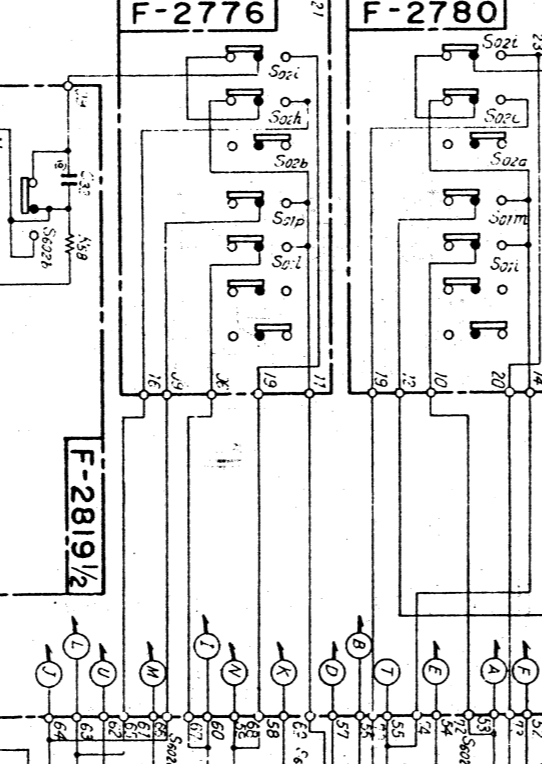
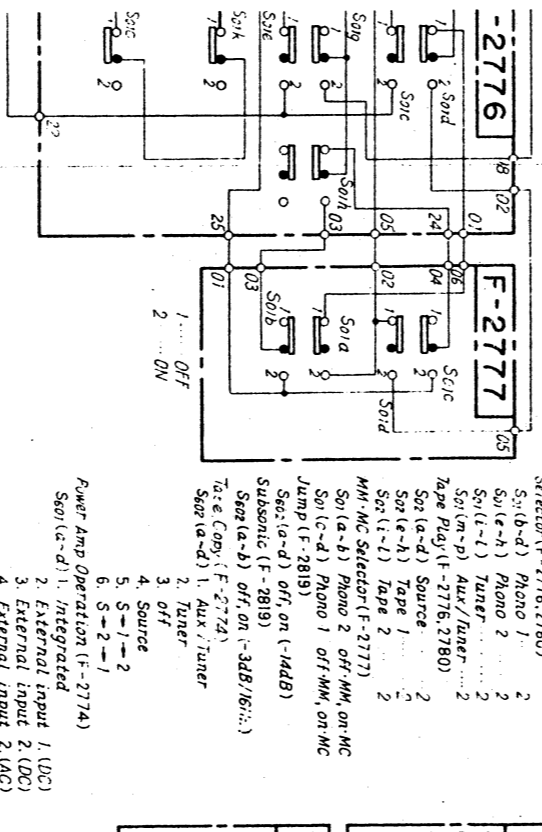
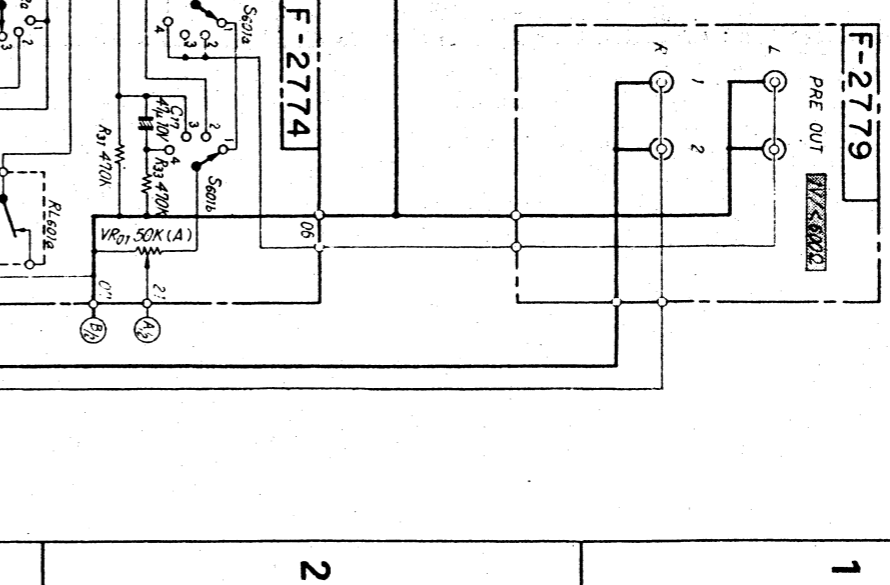
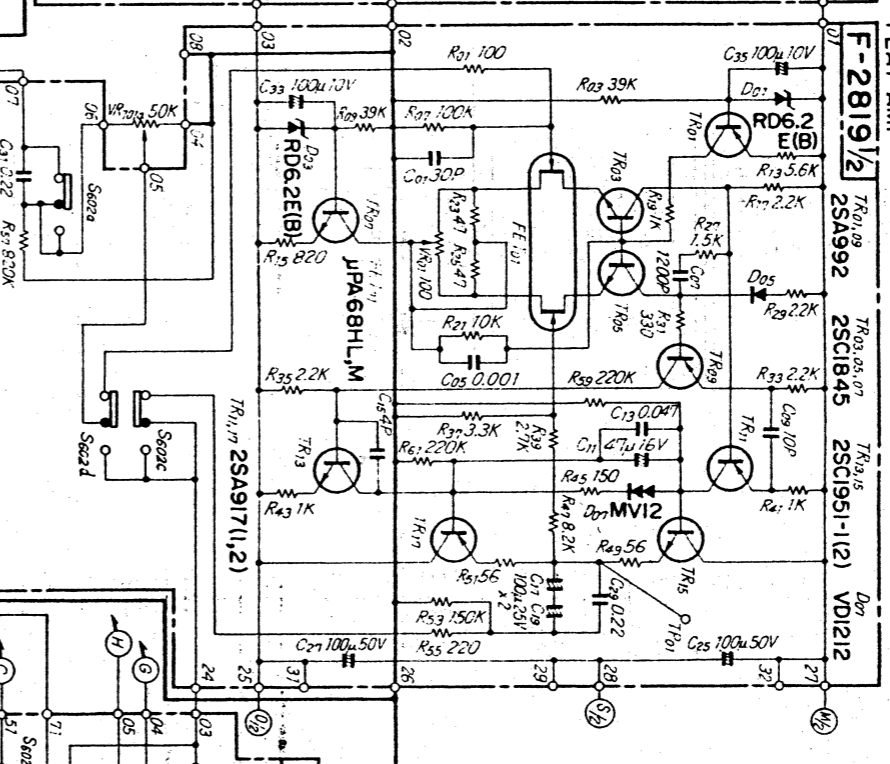
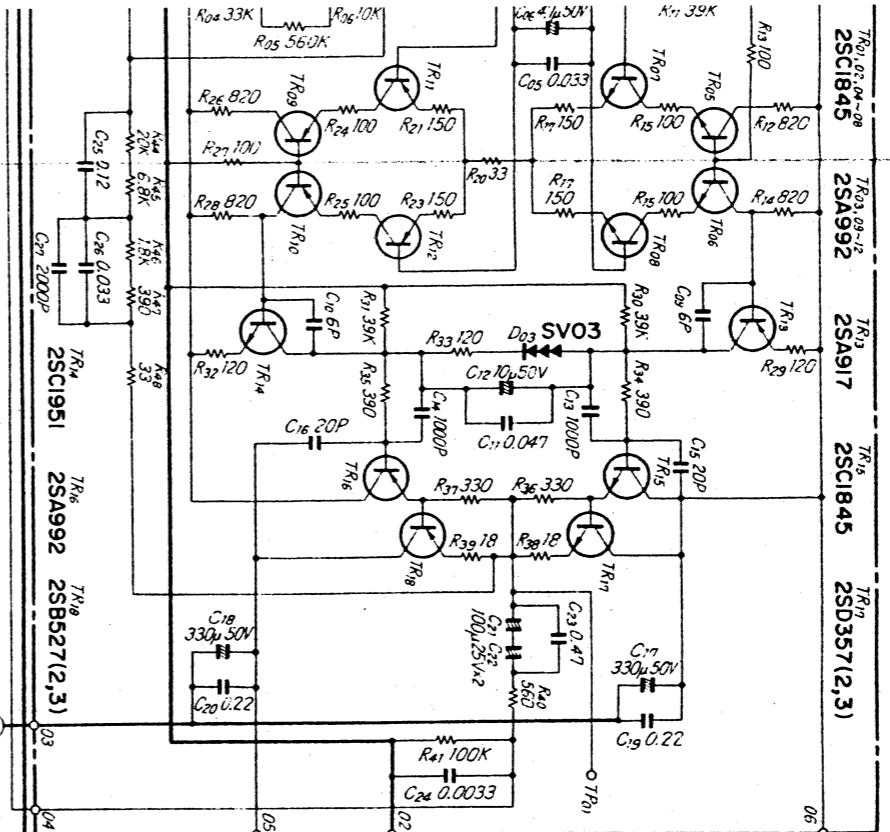

- SWITCHES & CONTROLS**
 Selector (F-2776, 2780)
 S1 (b-d) Phono 1
 S1 (b-h) Phono 2
 S1 (i-h) Tuner
 S1 (i-l) Tuner
 S1 (m-p) Aux/Tuner
 S2 (a-d) Source
 S2 (e-h) Tape 1
 S2 (i-l) Tape 2
 MM-NC Selector (F-2777)
 S3 (a-b) Phono 1 off MM, on MC
 S3 (c-d) Phono 1 off MM, on MC
 S3 (e-f) Phono 2 off MM, on MC
 S3 (g-h) Phono 2 off MM, on MC
 S3 (i-l) Phono 1 off MM, on MC
 S3 (m-p) Phono 2 off MM, on MC
 S4 (a-b) Phono 1 off MM, on MC
 S4 (c-d) Phono 2 off MM, on MC
 S4 (e-f) Phono 1 off MM, on MC
 S4 (g-h) Phono 2 off MM, on MC
 S4 (i-l) Phono 1 off MM, on MC
 S4 (m-p) Phono 2 off MM, on MC
 S5 (a-b) Phono 1 off MM, on MC
 S5 (c-d) Phono 2 off MM, on MC
 S5 (e-f) Phono 1 off MM, on MC
 S5 (g-h) Phono 2 off MM, on MC
 S5 (i-l) Phono 1 off MM, on MC
 S5 (m-p) Phono 2 off MM, on MC
 S6 (a-b) Phono 1 off MM, on MC
 S6 (c-d) Phono 2 off MM, on MC
 S6 (e-f) Phono 1 off MM, on MC
 S6 (g-h) Phono 2 off MM, on MC
 S6 (i-l) Phono 1 off MM, on MC
 S6 (m-p) Phono 2 off MM, on MC
 S7 (a-b) Phono 1 off MM, on MC
 S7 (c-d) Phono 2 off MM, on MC
 S7 (e-f) Phono 1 off MM, on MC
 S7 (g-h) Phono 2 off MM, on MC
 S7 (i-l) Phono 1 off MM, on MC
 S7 (m-p) Phono 2 off MM, on MC
 S8 (a-b) Phono 1 off MM, on MC
 S8 (c-d) Phono 2 off MM, on MC
 S8 (e-f) Phono 1 off MM, on MC
 S8 (g-h) Phono 2 off MM, on MC
 S8 (i-l) Phono 1 off MM, on MC
 S8 (m-p) Phono 2 off MM, on MC
 S9 (a-b) Phono 1 off MM, on MC
 S9 (c-d) Phono 2 off MM, on MC
 S9 (e-f) Phono 1 off MM, on MC
 S9 (g-h) Phono 2 off MM, on MC
 S9 (i-l) Phono 1 off MM, on MC
 S9 (m-p) Phono 2 off MM, on MC
 S10 (a-b) Phono 1 off MM, on MC
 S10 (c-d) Phono 2 off MM, on MC
 S10 (e-f) Phono 1 off MM, on MC
 S10 (g-h) Phono 2 off MM, on MC
 S10 (i-l) Phono 1 off MM, on MC
 S10 (m-p) Phono 2 off MM, on MC

- Power Amp Operation (F-2774)**
 S1 (a-d) 1. Integrated
 S1 (e-h) 2. External input 1 (DCI)
 S1 (i-l) 3. External input 2 (DCI)
 S1 (m-p) 4. External input 2 (ACI)
 S2 (a-b) 5. S-1-2
 S2 (c-d) 6. S-2-1
 S2 (e-f) 3. off
 S2 (g-h) 4. Source
 S2 (i-l) 2. Tuner
 S2 (m-p) 1. Aux/Tuner

6-2. Main Amp & Power Supply Section

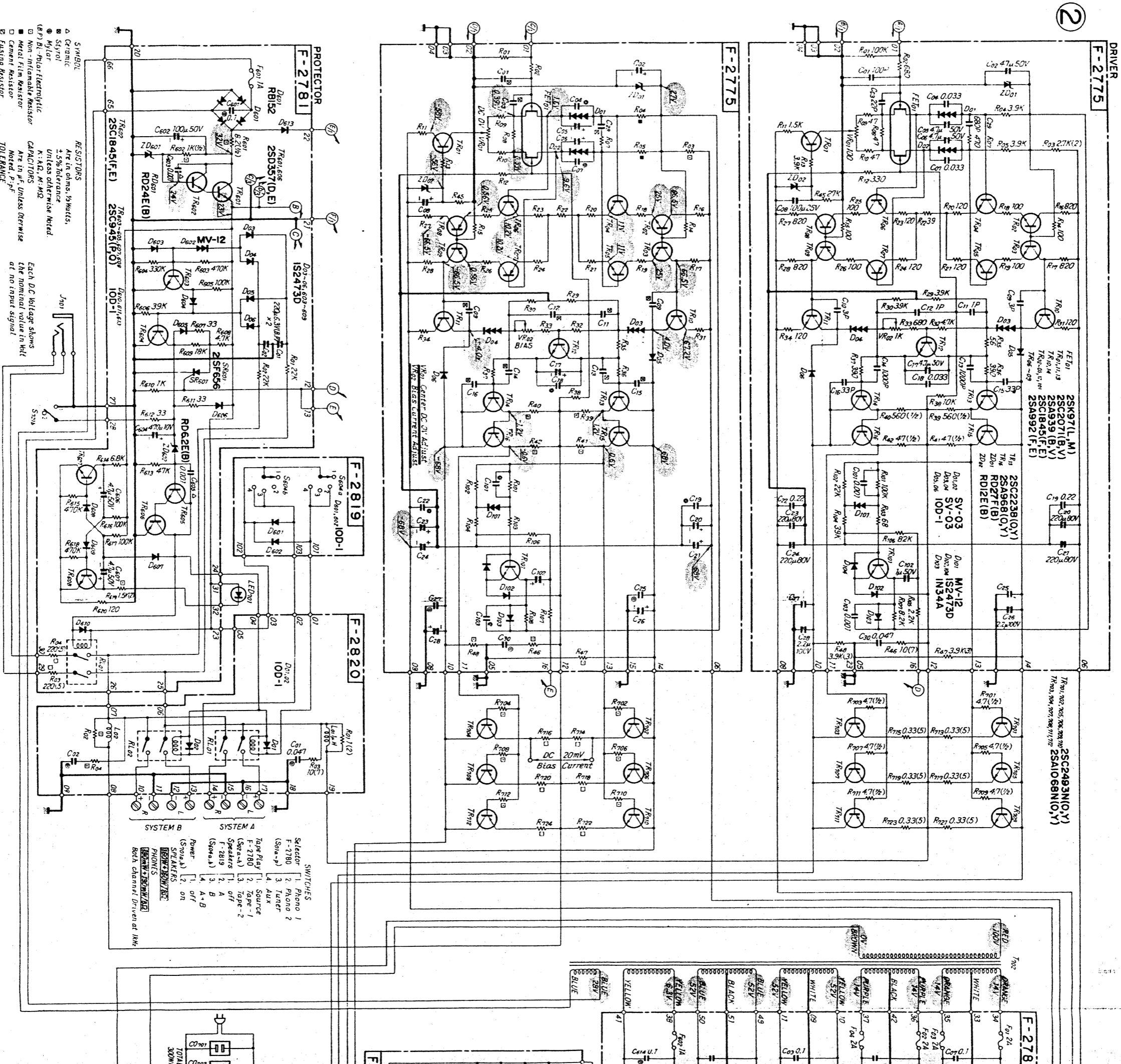

U-X1 AU-X1

Design and specifications subject to change without notice for improvement.
La présentation et les spécifications sont susceptibles d'être modifiées sans préavis par suite d'améliorations éventuelles.
Änderungen, die dem technischen Fortschritt dienen, bleiben vorbehalten.

E

F

G

H

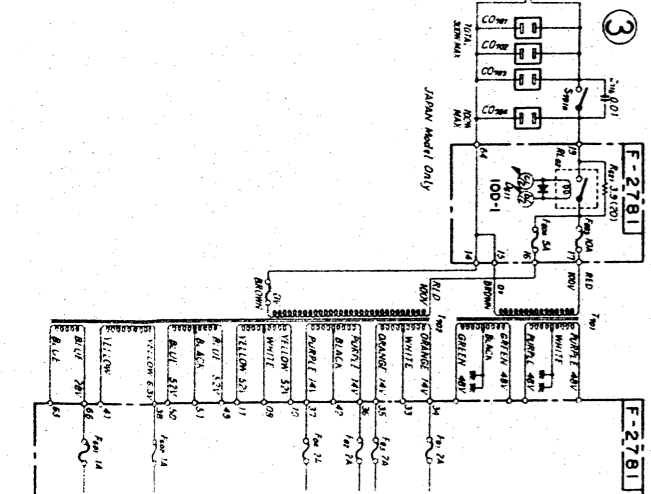
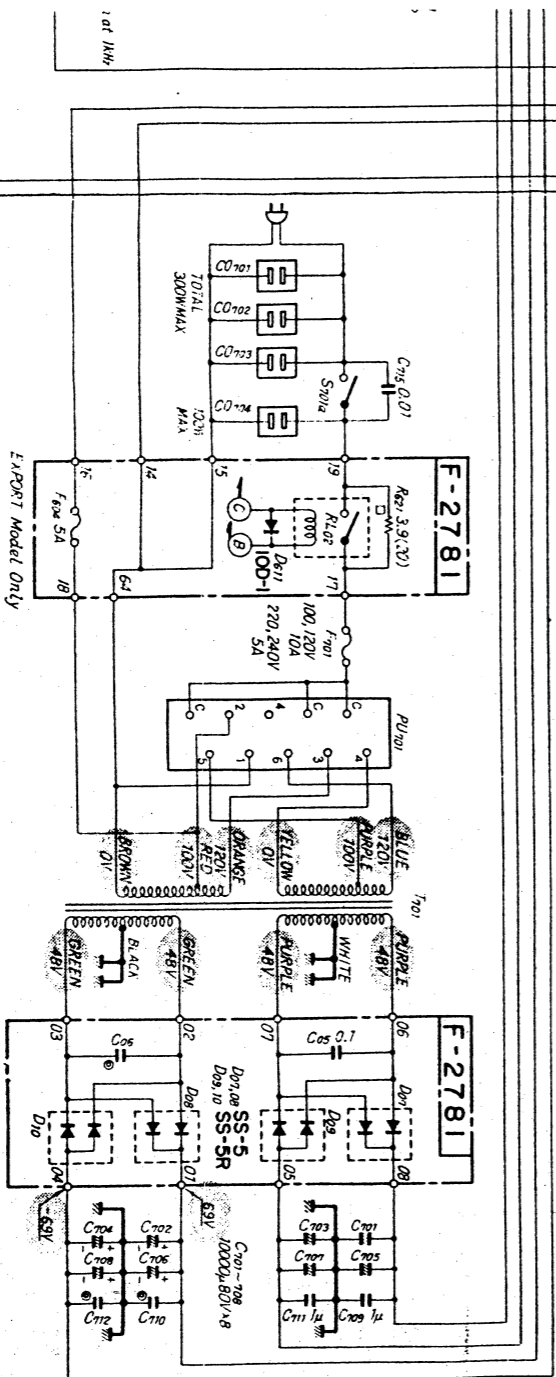
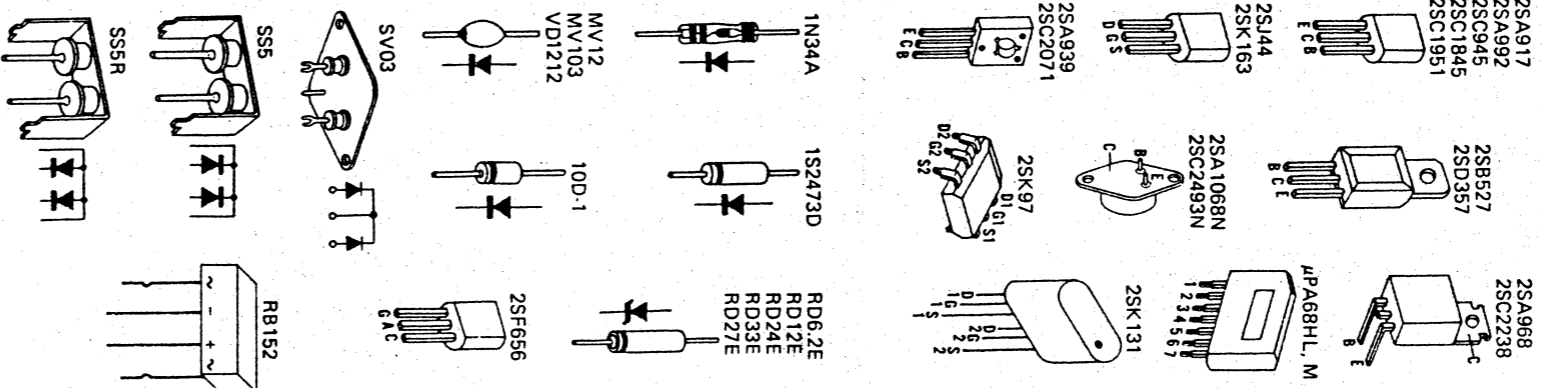
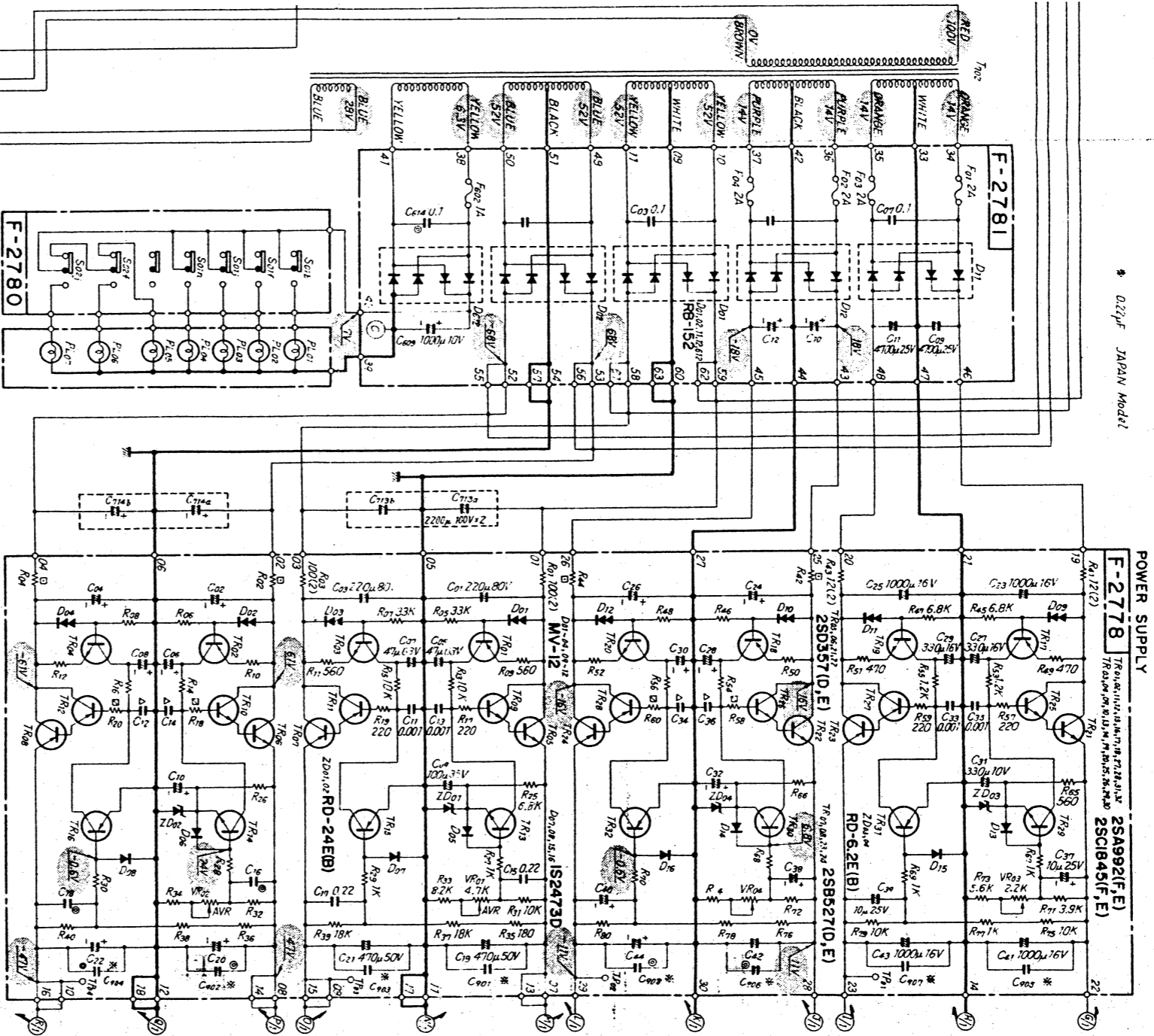

5

4

3

2

1

14

7. REPLACEMENT OF MAIN PARTS (See Vottom View on page 12)

1) Replacement of Driver circuit board, F-2775.

- * Remove bottom plate.
- * Remove 3p connector, A.
- * Disconnect +side of speaker cord, point B.
- * Disconnect earth wires (two pieces of black wires).
- * Loosen 4 screws fixing heat sink, then pull out the heat sink.

2) Replacement of Power transistor.

- * Pull out the heat sink by the same procedure of driver circuit board replacement above.
- * Loosen the screws mounting the power transistor and pluck out the transistor.

3) Replacement of Front panel Ass'y.

- * Remove bonnet.
- * Loosen 4 screws fixing front panel from both side.
- * Remove knobs.
- * Loosen a screw under the volume knob and take off a nut fixing speaker switch.

4) Replacement of flat amp & Tape copy switch circuit board, F-2819, F-2774.

- * Remove front panel ass'y & bonnet.
- * Loosen 4 screws fixing back panel to chassis, and pull out the back panel.

5) Replacement of speaker terminal board, F-2820 and protector relay.

- * Remove bottom plate & bonnet.
- * Loosen 8 screws fixing Rear panel to chassis.
- * Take off 8 of speaker terminal and remove speaker terminal circuit board from Rear panel.
- * Replace the protector relay.

8. PACKING LIST

Parts No.	Stock No.	Description
1	9116800	Vinyl Cover
2	9028310	Styrofoam Packing
3	9019520	Packing
4	9001570	Carton Case
5	5996080	Curl Stopper

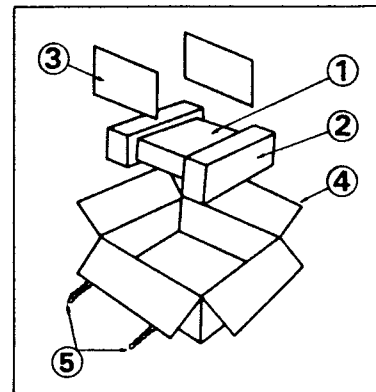

9. ACCESSORY PARTS LIST

Stock No.	Description
9203920	Operating Instructions
9238000	Schematic Diagram